

**ResMed**

**Astral™ series**



# Contents

<b>Introduction</b> .....	<b>1</b>
Indications for use .....	1
Indications for use (USA only).....	1
Contraindications.....	1
Adverse effects.....	2
General warnings and cautions.....	2
<b>The Astral device</b> .....	<b>4</b>
The Astral device interface .....	5
Touch screen.....	6
Information bar .....	7
Menu bar.....	8
Bottom bar .....	8
Main screen .....	8
Pressure bar .....	9
<b>Using the Astral device</b> .....	<b>10</b>
Using the Astral device for the first time .....	10
Powering on the device.....	11
Powering off the device .....	11
Enhanced access feature .....	12
Starting and stopping ventilation .....	14
Locking and unlocking the touch screen.....	14
Navigating the menus.....	15
Monitors menu .....	15
Setup menu .....	17
Alarms menu .....	17
Information menu .....	18
Device settings.....	18
Adjusting device settings .....	19
Programs.....	19
Manual Breath feature.....	20
Sigh Breath feature .....	20
Travelling with the Astral device .....	21
<b>Assembling patient circuits</b> .....	<b>21</b>
Circuit options .....	21
Fitting the circuit adapter.....	23
Connecting a single limb circuit with intentional leak.....	23
Connecting a single limb circuit for invasive use.....	24
Connecting a single limb circuit with expiratory valve.....	25
Connecting a double limb circuit (Astral 150 only) .....	27
Connecting a mouthpiece circuit .....	28
Learn Circuit .....	29

<b>Accessories .....</b>	<b>32</b>
Power accessories .....	32
Optional accessories .....	32
Attaching patient circuit accessories .....	32
Attaching a humidifier .....	33
Attaching a Heat Moisture Exchange (HME) .....	34
Attaching an antibacterial filter .....	34
Adding supplemental oxygen .....	35
Monitoring delivered oxygen .....	37
Attaching a nebuliser .....	37
Attaching other accessories .....	38
Attaching a pulse oximeter .....	38
Attaching a remote alarm .....	40
Power management .....	41
Connecting to mains power .....	42
Connecting the Astral External Battery .....	43
Connecting to a ResMed Power Station (RPSII) .....	44
Connecting to an external DC power source .....	44
Using the internal battery .....	45
Device power source indicators .....	47
Astral Carry Bag .....	48
<b>Alarms .....</b>	<b>49</b>
Alarm priority .....	50
Viewing the active alarms .....	52
Muting alarms .....	52
Resetting alarms .....	53
Adjusting the alarm volume .....	53
Testing the alarm sounders and indicators .....	54
Testing the Remote Alarm .....	55
Testing the alarms .....	55
Power alarms .....	56
<b>Detecting circuit disconnection and de-cannulation .....</b>	<b>57</b>
Astral Disconnection Alarm .....	58
Adjusting the Disconnection Alarm .....	58
<b>Data management process .....</b>	<b>59</b>
<b>Cleaning and maintenance .....</b>	<b>60</b>
Weekly .....	60
Monthly .....	60
Servicing .....	61
Replacing the air filter .....	61
Maintenance Timetable .....	62
Internal Battery .....	62
Device information .....	63
<b>Troubleshooting .....</b>	<b>64</b>
Alarm troubleshooting .....	64
Learn Circuit troubleshooting .....	68
General troubleshooting .....	71

<b>Technical specifications</b> .....	<b>72</b>
Guidance and Manufacturer’s Declaration Electromagnetic Emissions & Immunity .....	77
Guidance and manufacturer’s declaration—electromagnetic emissions.....	77
Guidance and manufacturer’s declaration – electromagnetic immunity.....	78
Recommended separation distances between portable and mobile	
RF communications equipment and the life support device .....	80
Potential impact of electromagnetic disturbances .....	80
<b>Symbols</b> .....	<b>81</b>
<b>Standards compliance</b> .....	<b>82</b>
<b>Training and support</b> .....	<b>82</b>
<b>Limited warranty</b> .....	<b>83</b>
<b>Appendix A: Definitions</b> .....	<b>84</b>
Ventilation settings definitions.....	84
Measured and calculated parameter definitions .....	86

## Introduction

The Astral device provides mechanical ventilation to both ventilation dependent and non-dependent patients. It delivers pressure and volume ventilation through either a valve or leak circuit, and is compatible with a range of accessories to support specific use cases.

The information in this guide applies to both the Astral 100 and the Astral 150 devices. Where information applies to only one of these devices, that device will be specified.

**Note:** Some features may not be available on your device.

This User Guide is for a patient or carer user, and does not contain all the information provided in the Clinical Guide.

### WARNING

---

- Read the entire manual before using the Astral device.
  - Use the Astral device only as directed by a physician or healthcare provider.
  - Use the Astral device only for the intended use as described in this manual. Advice contained in this manual does not supersede instructions given by the prescribing physician.
  - Install and configure the Astral device in accordance with the instructions provided in this guide.
- 

### CAUTION

---

In the US, Federal law restricts this device to sale by or on the order of a physician.

---

## Indications for use

The Astral 100/150 provides continuous or intermittent ventilatory support for patients weighing more than 5 kg who require mechanical ventilation. The Astral device is intended to be used in home, institution/hospital and portable applications for both invasive and non-invasive ventilation.

### Indications for use (USA only)

The Astral 100/150 provides continuous or intermittent ventilatory support for patients weighing more than 11 lb (5 kg) who require mechanical ventilation.

The iVAPS mode with optional AutoEPAP is intended for patients weighing more than 66 lb (30 kg).

The Astral device is intended to be used in home, institution/hospital and portable applications for both invasive and non-invasive ventilation.

### CAUTION

---

The Astral device is not intended for use as an emergency transport ventilator.

---

## Contraindications

The Astral device is contraindicated in patients with the following pre-existing conditions:

- pneumothorax or pneumomediastinum
- pathologically low blood pressure, particularly if associated with intravascular volume depletion
- cerebrospinal fluid leak, recent cranial surgery or trauma
- severe bullous lung disease
- dehydration.

## WARNING

---

AutoEPAP is contraindicated when using an invasive interface.

---

### Adverse effects

Report unusual chest pain, severe headache or increased breathlessness to your physician. The following side effects may arise during use of the device:

- drying of the nose, mouth or throat
- nosebleed
- bloating
- ear or sinus discomfort
- eye irritations
- skin rashes.

### General warnings and cautions

The following are general warnings and cautions. Further specific warnings, cautions and notes appear next to the relevant instruction in the manual.

A **warning** alerts you to possible injury.

## WARNING

---

- If you notice any unexplained changes in the performance of the device, if it is making unusual or harsh sounds, if the device or the power supply are dropped or mishandled discontinue use and contact your healthcare provider.
- For ventilator-dependent patients, always have alternate ventilation equipment available, such as a back-up ventilator, manual resuscitator or similar device. Failure to do so may result in patient injury or death.
- The Astral device is a restricted medical device intended for use by qualified, trained personnel under the direction of a physician. Clinical supervision is required in critical care/intensive care unit environments.
- Ventilator-dependent patients should be continuously monitored by qualified personnel or adequately trained carers. These personnel and carers must be capable of taking the necessary corrective action in the event of a ventilator alarm or malfunction.
- The internal battery is not intended to serve as a primary power source. It should only be used when other sources are not available or briefly when necessary; for example, when changing power sources.
- The Astral device is not intended to be operated by persons (including children) with reduced physical, sensory or mental capabilities without adequate supervision by a person responsible for the patient's safety.
- The Astral device is not intended to be operated by patients unless they have been given adequate instruction concerning the operation of the device by a person responsible for the patient's safety.
- The Astral device must not be used in the vicinity of an MRI or diathermy device.
- The effectiveness of ventilation and alarms should be verified including after any ventilation or alarm setting change, any change in circuit configuration, or after a change to co-therapy (eg, nebulisation, oxygen flow).
- The Astral device and AC Power Supply can get hot during operation. To prevent possible skin damage do not leave the Astral device or AC Power Supply in direct contact with the patient for extended periods of time.

- The device can provide therapies typically associated with both ventilator-dependent and non-dependent patients. The mode of ventilation, circuit type, and alarm strategies should be chosen after a clinical evaluation of each patient's needs.
  - The device must not be used at an altitude above 9842 ft (3000 m) or outside the temperature range of 32–104°F (0–40°C). Using the device outside these conditions can affect device performance which can result in patient injury or death.
- 

A caution explains special measures for the safe and effective use of the device.

 **CAUTION**

- Repairs and servicing of the device should only be performed by an authorized ResMed service representative.
  - The temperature of the airflow for breathing produced by the device can be as much as 43°F (6°C) higher than the temperature of the room. Caution should be exercised if the room temperature is warmer than 95°F (35°C).
  - Do not expose the device to excessive force, dropping or shaking.
  - Dusty environments may affect device performance.
  - The Astral device may be used in the vicinity of electronic article surveillance (EAS) systems during mobile situations when attached to the patient or patient's wheelchair. The Astral device may experience interference in the vicinity of EAS. Keep the Astral device at least 8" (20 cm) away from the EAS. Note that the EAS might be concealed. If you experience any type of electromagnetic interference, move away from the suspected source.
- 

A note advises of special product features.

**Notes:**

- For assistance and reporting of issues associated with the Astral device, contact your Health Care Provider or authorised ResMed representative.

## The Astral device

# The Astral device

The following images describe the components of the Astral device.



### Description

1	Adapter port Can be fitted with single limb adapter, single limb leak adapter or double limb adapter (Astral 150 only).
2	Handle
3	Inspiratory port (to patient) Provides an outlet for pressurised air to be delivered to the patient via the patient circuit. Includes FiO <sub>2</sub> sensor on the Astral 150. The FiO <sub>2</sub> sensor is an optional accessory on the Astral 100.
4	Ethernet connector (service use only)
5	USB connector (for download to ResScan and connection of approved accessories)
6	Mini USB connector (for connection to RCM or RCMH)
4	



Description	
7	DC power inlet
8	Device on/off push button
9	SpO <sub>2</sub> Sensor connector
10	Remote alarm five pin connector
11	Low flow oxygen input (up to 30 L/min)
12	Air inlet (complete with hypoallergenic filter)

## The Astral device interface



The interface of the Astral device comprises several different features described in the following image.



Description	
1	Touch screen
2	Power source indicators <ul style="list-style-type: none"> <li>●  AC (mains power supply)</li> <li>●  DC (external battery or car accessory adapter or RPSII)</li> <li>●  Internal battery</li> </ul>
3	Therapy on/off indicator <ul style="list-style-type: none"> <li> <b>Device ready</b> Constant green display when the device is turned on but not ventilating.</li> <li> <b>Device ventilating</b> Flashes blue when the device is ventilating and the Ventilation LED setting is 'ON'. Otherwise is 'OFF'.</li> </ul>

## The Astral device

### Description

- |   |   |                       |
|---|---|-----------------------|
| 4 | Alarm mute/reset button   |                       |
|   | Illuminates when an alarm is triggered and flashes when the sound is muted.                       |                       |
| 5 | Alarm bar   |                       |
|   |  Flashing red    | High priority alarm   |
|   |  Flashing yellow | Medium priority alarm |
|   |  Constant yellow | Low priority alarm    |

## Touch screen

The main method of interacting with the Astral device is via the touch screen. The display on the touch screen changes according to the function being performed.

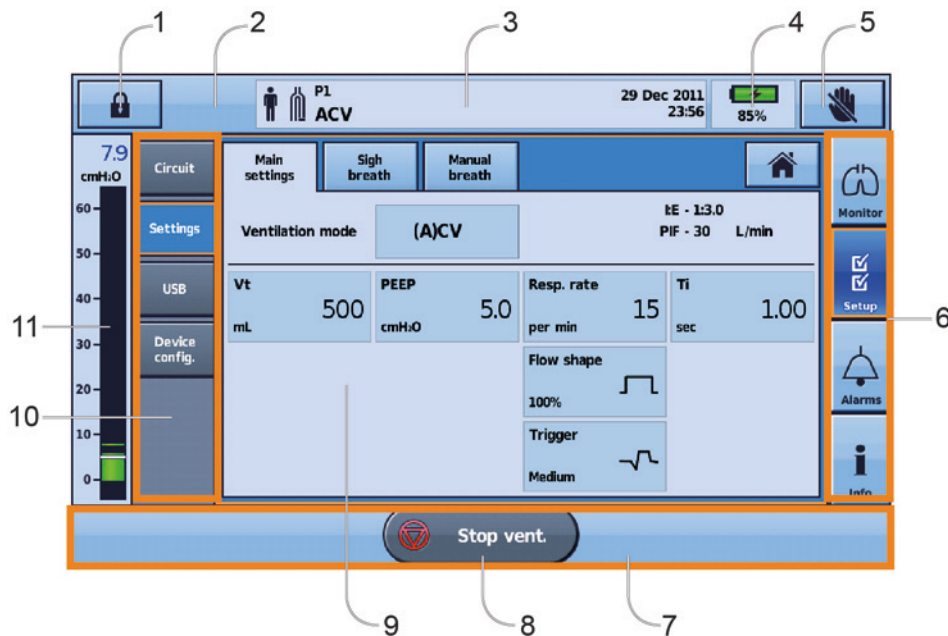

### Description

- 1 Clinical mode access button



Locked



Unlocked

- 2 Manual breath button



only shown if enabled

- 3 Information bar

- 4 Internal battery indicator



100%



8h00



70%

- 5 Lock touch screen button

- 6 Menu bar

- 7 Bottom bar

- 6





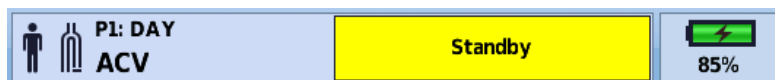

	Description
8	Start/Stop ventilation button
9	Main screen
10	Sub-menus
11	Pressure bar

**Note:** Do not access Clinical mode  unless directed by a clinician.

## Information bar

The Information bar is displayed at the top of the touch screen. The Information bar displays the operating status of the device, including patient type, current circuit configuration, programs, information messages, ventilation status, alarms and power status.



	Description
	Patient type – Adult
	Patient type – Pediatric
	Circuit type – Single limb with intentional leak
	Circuit type – Single limb with expiratory valve
	Circuit type – Double limb
	Circuit type – Mouthpiece
P1:DAY	Program number and program name
(A)CV	Ventilation mode
	Multiple alarms are active simultaneously. The highest priority active alarm is displayed first.
Message window	Will display alarms or information. Image above shows device in Standby. (Displayed when the device is powered on but not ventilating). Date and time will be displayed when the device is ventilating and there are no active alarms.  Information messages are displayed in blue text. If the device Alert tone setting is 'On', you will be alerted to new information messages by a single beep.

## The Astral device

### Menu bar

The Menu bar provides access to the four main menus in the Astral device.



#### Monitors menu

View real-time patient data in either waveform or monitoring formats including pressure, flow, leak, tidal volume, synchronisation and oximetry.



#### Setup menu

Configure and view ventilation therapy or device settings; and import/export data.



#### Alarms menu

Configure and view alarms including alarm volume.



#### Information summary menu

View therapy statistics, used hours, events, reminder and device information.

### Bottom bar

The Bottom bar changes with the function of the device.

It can display buttons to Stop or Start ventilation and Apply or Cancel functions.

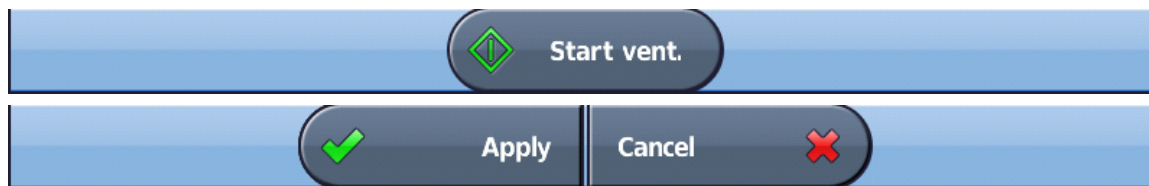



### Main screen

The Main screen displays the monitoring data, ventilation and device controls. Each function is accessed through the various menus and tabs.



## Pressure bar

The Pressure bar displays real-time therapy data while the Astral device is ventilating.

Patient pressure is shown as a bar graph. Peak inspiratory pressure is shown as a numerical value and watermark. Spontaneously triggering and cycling is indicated by  and .

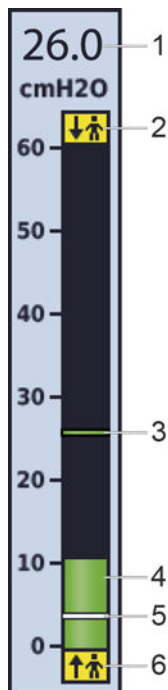
The example below displays the pressure bar when a patient is spontaneously breathing.



	Description
1	Peak inspiratory pressure (PIP) value
2	 Spontaneous cycled breath marker—indicates patient-cycled breath
3	Peak inspiratory pressure marker
4	Current pressure
5	Positive end expiratory pressure (PEEP) setting
6	 Spontaneous triggered breath marker—indicates patient-triggered breath

## Using the Astral device

### WARNING

---

Make sure the area around the device is dry, clean and clear of bedding or clothes or other objects that could block the air inlet. Blocking the cooling vents could lead to overheating of the device. Blocking the air inlet could lead to patient injury.

---

### CAUTION

---

- To prevent possible damage to the ventilator, always secure it to its stand or place it on a flat, stable surface. For mobile situations, ensure the Astral device is contained within its mobility bag.
  - Ensure the device is protected against water if used outdoors.
- 

## Using the Astral device for the first time

When using the Astral device for the first time, ResMed recommends you first perform a functional test. A functional test will ensure the device is in proper working order before starting therapy. Information to assist you in resolving any issues is available in the Troubleshooting (see page 64) section.

### CAUTION

---

If any of the following checks fail, contact your Healthcare provider or ResMed for assistance.

---

#### To perform a functional test:

1. Turn off the device by pressing the power switch at the back of the device.
2. Check the condition of the device and accessories.  
Inspect the device and all accessories. Damaged components should not be used.
3. Check the patient circuit setup.  
Check the integrity of the patient circuit (device and provided accessories) and that all connections are secure.
4. Turn on the device and test alarms.

### WARNING

---

If no alarm sounds, do not use the ventilator.

---

- Press the power switch at the back of the device to turn on the device. Check that the alarm sounds two test beeps and the LEDs for the alarm signal and the alarm mute/reset button flash. The device is ready for use when the Patient Home screen is displayed.
5. Disconnect the device from the mains and external battery (if in use) so that the device is powered by the internal battery. Check that the Battery Use alarm is displayed and the battery LED is on.  
**Note:** If the charge state of the internal battery is too low an alarm occurs. Refer to Troubleshooting (see page 64).
  6. Reconnect the external battery (if in use) and check that the LED for the DC power supply is lit. The External DC Power Use alarm will be displayed and the Alarm LED will light.
  7. Reconnect the device to mains power.
  8. Check the pulse oximeter sensor (if in use).  
Attach the accessories according to the set up descriptions. From the Monitoring menu, go to the Monitoring screen. Check that the values for SpO<sub>2</sub> and pulse are displayed.
  9. Check the oxygen connection (if in use). Check for damage to hoses or leaks. Check remaining capacity of oxygen cylinders.
  10. Perform a Learn Circuit.

## Powering on the device

To power on the Astral device, simply press the green power on/off button at the back of the device. The device will perform a system check as shown on the main screen.

On completion of the system check, the Patient Home screen and active program is displayed.

**Note:** Settings configured in the active program will be used when ventilation is started.



### Helpful hint!

If more than one program displays on the Patient Home screen, the active program will be highlighted orange. For further information, refer to Programs (see page 19).

For information on powering the Astral device, refer to Power.

## Powering off the device

The Astral device can only be powered off when ventilation is stopped.

Removing AC power does not power off the device. The device remains powered on internal battery.

Turning off the device must be done manually and must be performed before leaving the device disconnected from AC power for any extended period of time. Failure to do so may result in battery depletion and activation of alarms.

To power off the device, press the green on/off button at the back of the device and follow the on-screen prompts. To ensure the device is fully powered down, touch the screen.

**Note:** While the device remains connected to external mains power, the internal battery continues to charge.

## Enhanced access feature

The Astral device offers an enhanced access feature ('Big buttons' mode) to provide you with easier usability and accessibility. The 'Big buttons' mode can be used to start and stop ventilation, as well as to mute alarms.

### WARNING

To prevent inadvertent alarm mute or reset, do not leave the patient in contact with the device screen.



To enable the 'Big buttons' mode:

1. From the Main menu press Setup . The Setup menu is displayed.
2. Select the Patient Access tab from the Device Config. menu.

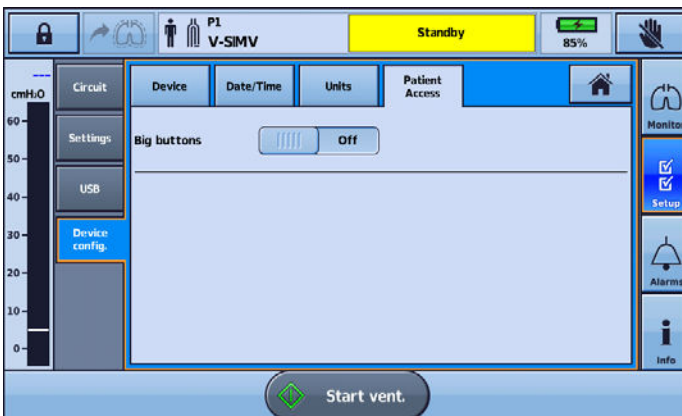

3. Move the Big buttons slider to On.

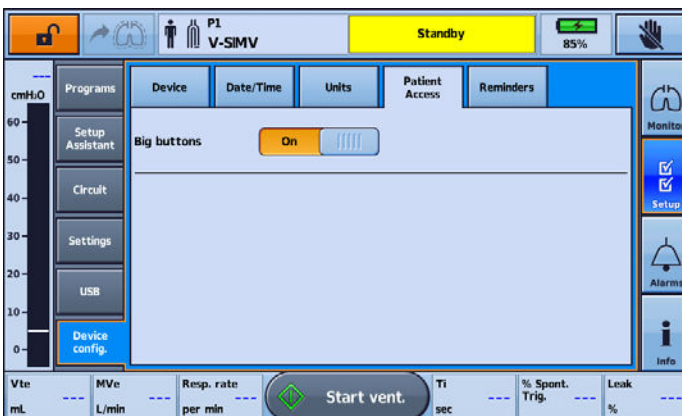



Your enhanced access feature is now enabled.

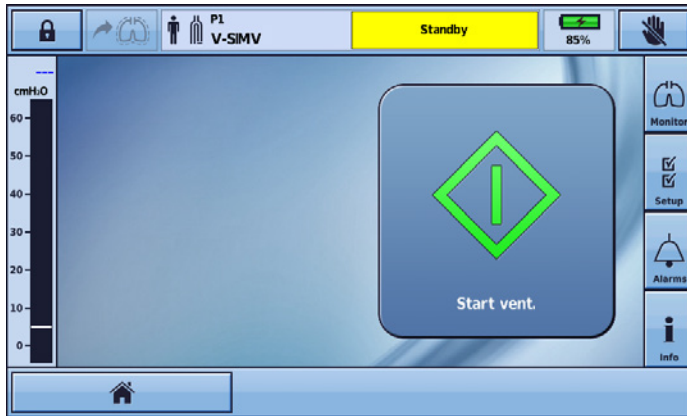

With this feature enabled, it is possible to switch between 'Big buttons' mode and standard. Simply select the Home button from left hand corner of the Bottom bar.

Your screen will return to standard button size and the Home icon will be replaced by the Big buttons

icon .

To return to 'Big buttons' mode, simply select the Big buttons icon from the bottom bar.



**Note:** With the enhanced access feature enabled, your screen will return to 'Big buttons' mode once the screen locks (after two minutes of inactivity).

## Starting and stopping ventilation

Your clinician has set up one or more ventilation programs for your therapy. If more than one program has been set up, follow the directions given by your clinician for when and how each program should be used.



**Note:** If using the device for the first time, ResMed recommends performing a functional test before starting ventilation. Refer to Using the Astral device for the first time (see page 10).

### To start ventilation:

1. Press the green on/off button at the back of the device (if power is not already on).
2. Press . Ventilation is started.
3. Add oxygen if required.

### To stop ventilation:

Ventilation can be stopped at any time and from any screen.

1. If oxygen is connected, turn off the oxygen.
2. Press and hold .
3. Release  when prompted.
4. Press **Confirm**. Ventilation is stopped.

## Locking and unlocking the touch screen

The touch screen can be unlocked at any time.

To manually lock the touch screen, from the Information bar press . When the touch screen is locked the button is highlighted orange.

### Unlocking the touch screen

Touch the screen anywhere and follow the on-screen prompts.

## Navigating the menus

The Astral device has four menus accessible via the Menu bar. Each menu is further broken down into various sub-menus.

### Monitors menu

The Monitors menu allows you to view real-time ventilation data and is comprised of three sub-menus:

- Waveforms
- Monitoring
- Trends

#### Waveforms

The Waveforms screen displays the last 15 seconds of patient airway pressure and flow in a graph. The graph updates in real-time and when necessary the vertical axis will auto scale to accommodate changes in amplitude.

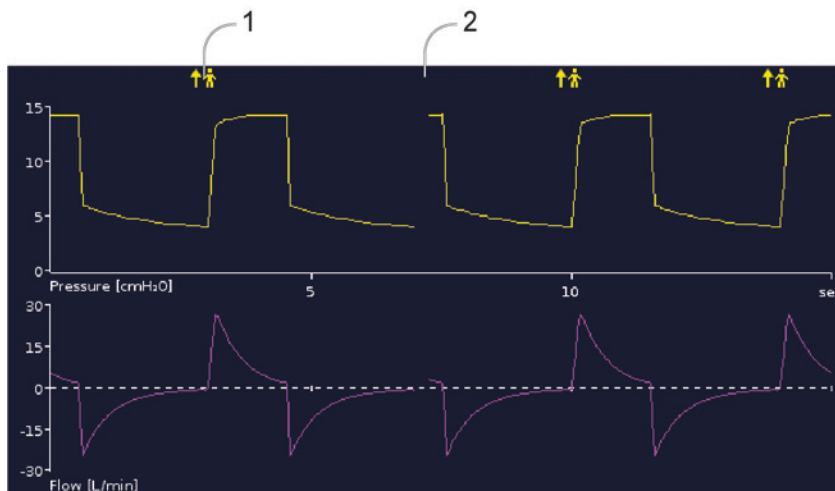

#### Description

- 
- |   |   |   |
|---|---|---|
| 1 |  | Spontaneous trigger breath marker—indicates patient-triggered breath.       |
| 2 |   | Break in graph—indicates the current position and moves from left to right. |
-

## Using the Astral device

### Monitoring screen

The Monitoring screen displays all measured parameters in numerical form.

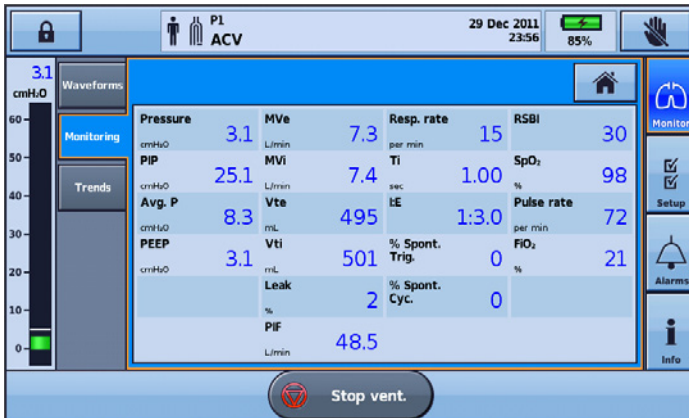

### Helpful hint!

Your care provider may ask you to access this screen and report values from time to time.

### Trends screen

The Trends screen shows the 5th and 95th percentile values, as well as the median for the last 30 days for each of the following parameters:

- Leak
- Minute ventilation
- Peak inspiratory pressure
- Tidal volume
- Respiratory rate
- Inspiratory time
- SpO<sub>2</sub>
- Pulse rate
- FiO<sub>2</sub>
- Alveolar ventilation.

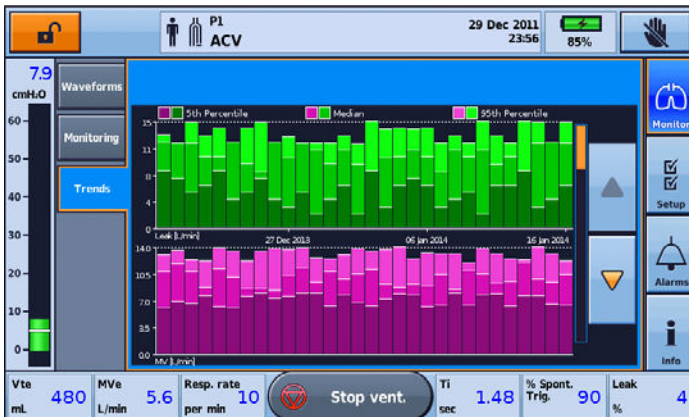

Information is displayed as bar graphs, with two graphs per screen.

Use the up and down scroll arrows to cycle through the graphs.

## Setup menu

The Setup menu displays four different sub-menus:

- Circuit—to view the circuit
- Settings—to view the ventilation mode and access Manual Breath and Sigh Breath screens
- USB—to save patient data and import/export settings
- Device Config.—to change the device configuration.



### Helpful hint!

Therapy and alarm settings can be viewed as 'read only' in Patient mode (ie, with Clinical mode locked .

## Alarms menu

The Alarms menu displays the individual thresholds for each alarm to trigger. Real-time values are displayed between the upper and lower thresholds.

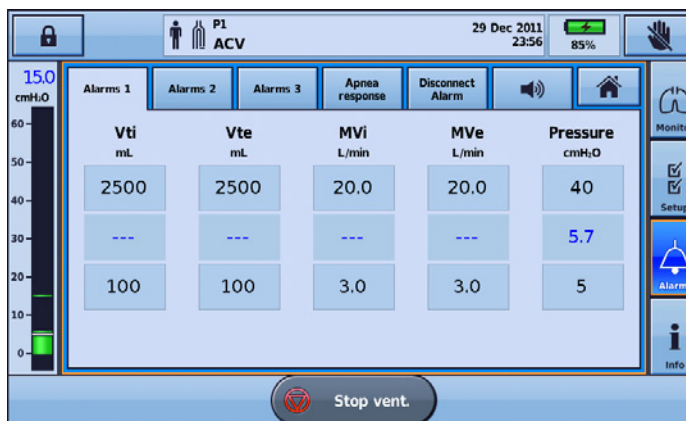

## Information menu

The Information menu is comprised of three sub-menus:

- Events—all logged event activity that has taken place is displayed. A breakdown of specific alarms, settings or system events can also be viewed.
- Device—information about the actual device is displayed, eg, Model and Serial numbers, Software version, and Next service due date.
- Battery—information about the state of charge of the internal and external batteries when connected including the combined total battery charge.

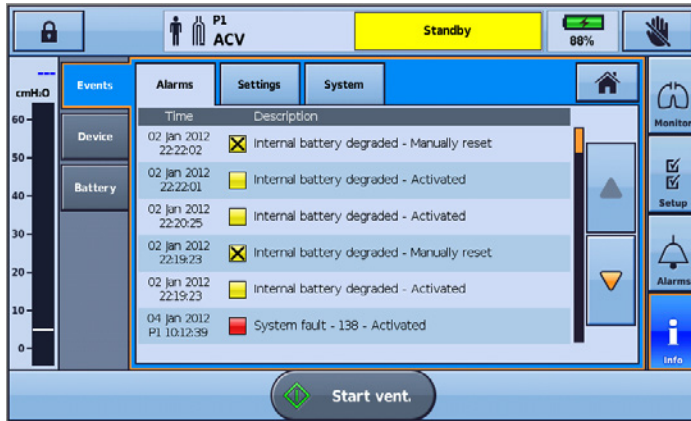

## Device settings

The configurable settings are described in the following table.

Device setting	Description
Alert Tone	Sets alert tones to on or off. Default: On
Alarm Volume	Sets the volume level of the alarm system. Settings from 1, 2, 3, 4 or 5. Default: 3
Auto power off	Automatically powers off the device after 15 minutes of inactivity. Conditions: The device is in Ventilation standby mode (not ventilating), is being powered by the Internal battery or an External battery and there are no active alarms. Default: On
Display Brightness	Sets the brightness of the screen from Auto with a selection of five different brightness levels. Default: Auto
Backlight timeout	Allows the screen backlight to turn off (go black) if the screen has not been touched for two minutes or more and there are no active alarms. Setting to 'Off' will mean the screen back-light will be permanently on. Default: On
Rotate Display	Flips the current orientation of the display.
Device Vent LED	Sets the status of the Ventilation active LED to On or Off during ventilation. Default: On
Date	Allows setting of the day, month and year of the current date.

Device setting	Description
Time	Allows setting of the hours and minutes of the current time.
Language	Sets the current language of the device selected from the list of available languages.

## Adjusting device settings

Access adjustable device settings from the **Setup** menu and select **Device Config**.

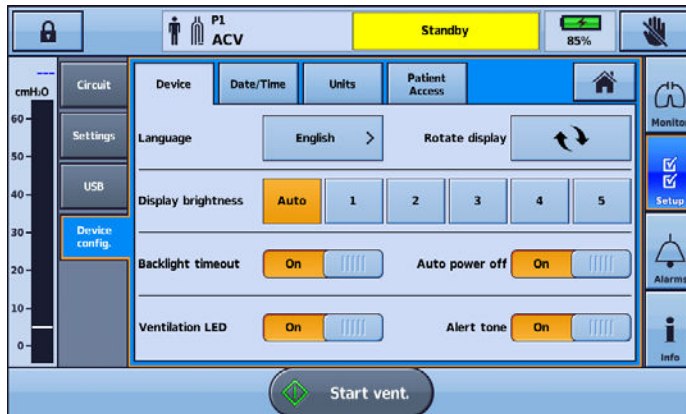

The current active selections are highlighted in orange.

To change settings, simply select another of the available options. The revised setting is highlighted in orange.

## Programs

Programs on the Astral device can be configured by your clinician to provide you with alternate treatment options. For example, a clinician can set up programs for sleeping versus daytime use, or for use during exercise or physiotherapy. Programs allow for different circuit, ventilation and alarm settings.

The Astral device comes with one standard active program. Your clinician can configure up to three additional programs (if available).

If any additional programs have been set up by your physician, they can be selected for use from the Patient home screen. You can change between programs while the Astral device is delivering ventilation. Changing between programs will cause ventilation and alarm settings to change, as configured by your clinician.



## Using the Astral device

### To change between programs:

1. From the Patient home screen, select the program you want to use. A summary of the program settings will be displayed.

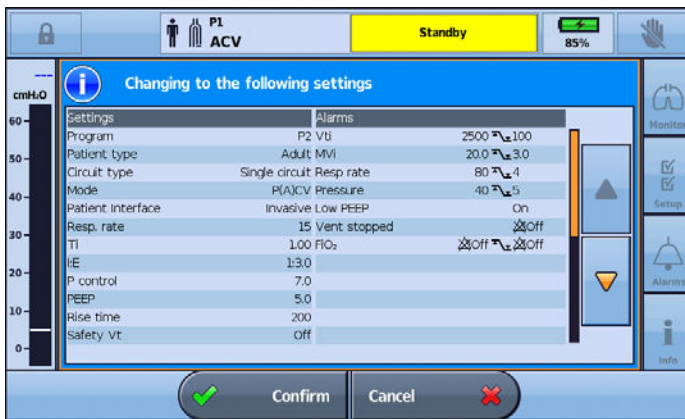

2. Press **Confirm** to proceed with the change. The selected program becomes active and will be highlighted orange.



**Note:** To change to a program with a different circuit type, you will need to stop ventilation. When you have changed the circuit and the program, you can restart ventilation.

### Helpful hint!

If more than one program has been set up, follow the directions given by your clinician for when and how each program should be used.

## Manual Breath feature

Your clinician may have enabled the Manual Breath feature. This feature allows a larger than normal breath to be delivered.

To deliver a manual breath, press .

## Sigh Breath feature

Your clinician may have enabled the Sigh Breath feature. This feature delivers a larger 'sigh' breath at a regular interval.

If configured, the Astral device will beep with a Sigh Alert prior to the Sigh Breath.

### To turn the Sigh Alert on or off:

1. From the Setup menu, select **Settings**.
2. Set Sigh Alert on or off.
3. Press **Apply** to proceed with the change.



## Travelling with the Astral device

### WARNING

The Astral device should not be operated while in the Carry Bag. To ventilate while travelling, use the Mobility Bag or SlimFit Mobility bag.

When travelling with the Astral device:

- The Astral device should always be packed in its carry bag when not in use to prevent damage to the device.
- The carry bag is for carry-on luggage only. The carry bag will not protect the Astral device if it is put through checked baggage.
- For your convenience at security stations, it may be helpful to keep a printed copy of the user guide in the Astral carry bag to help security personnel understand the device and refer them to the following statement.
- ResMed confirms that the Astral device meets the Federal Aviation Administration (FAA) requirements (RTCA/DO-160, section 21, category M) for all phases of air travel.
- For power management tips, refer to Power management (see page 41).

## Assembling patient circuits

### Circuit options

The Astral device supports a range of circuits (the device and accessories assembled together) to suit individual patient needs. The device uses interchangeable circuit adapters.

The following table may assist in selecting suitable circuits and settings for different patient types:

Tidal volume range	Recommended patient type setting	Suitable circuit diameters
50 mL to 300 mL	Pediatric	10 mm, 15 mm or 22 mm
> 300 mL	Adult	15 mm or 22 mm

### WARNING

- Use a double limb circuit for direct measurement of exhaled volumes. In this configuration, the expired volume is returned to the ventilator for independent measurement. (Astral 150 only)
- The Astral device does not support monitoring of exhaled volumes when used with a single limb circuit with expiratory valve.
- The patient circuit should be arranged so as not to restrict movement or pose a strangulation risk.
- Only use circuit components that comply with the relevant safety standards including ISO 5356-1 and ISO 5367.



### CAUTION

For pediatric use, ensure that the patient circuit type fits and is suitable for use with a child. Use a pediatric patient type for patients that weigh less than 23 kg and normally require less than 300 mL tidal volume.

## Assembling patient circuits

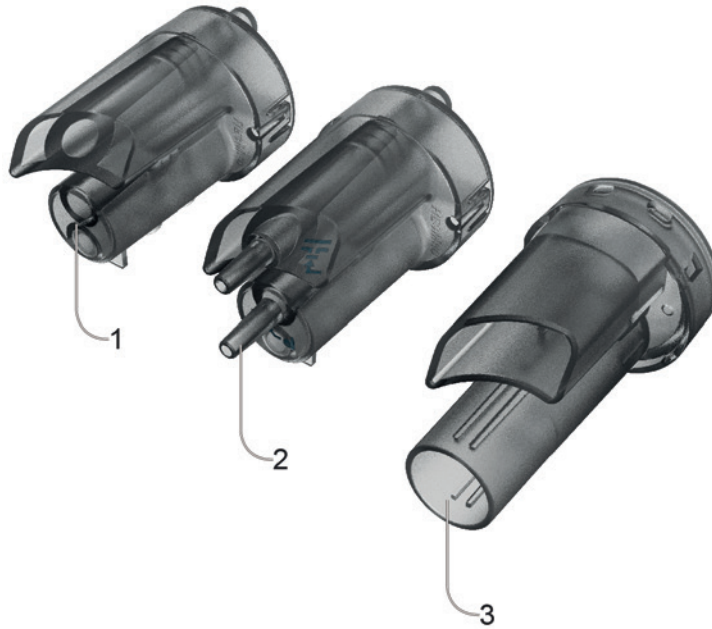
There are three circuit adapters:



Adapter		For use with
1	Single limb leak	 Single limb circuit with intentional leak or mouthpiece circuit
2	Single limb	 Single limb circuit with expiratory valve (expiratory valve integrated into the circuit)
3	Double limb (Astral 150 only)	 Double limb circuit (expiratory valve integrated into the adapter) OR single limb circuit with intentional leak or mouthpiece circuit

A Learn Circuit should be performed after any change of circuit. Astral will provide accurate therapy as long as the Learn Circuit is completed. Refer to Learn Circuit (see page 29) for further information.

### WARNING

The measurement of patient exhaled gas volume may be affected by leak.

### Helpful hint!

Only use adapters and circuits as directed by your clinician.

## Fitting the circuit adapter

Before connecting the patient circuit, the adapter specific to the required circuit type must be fitted.

To fit the adapter:

1. Turn over the device and place on a soft surface (to protect the LCD screen).
2. Press and hold the eject button. Pull the cover out towards you.
3. Lift the adapter out of the socket.
4. Replace with the new adapter, ensuring it sits firmly in the socket.
5. Place the cover over the enclosure, ensuring the runners on the device and the cover are aligned. Slide the cover back into place until the latch clicks.

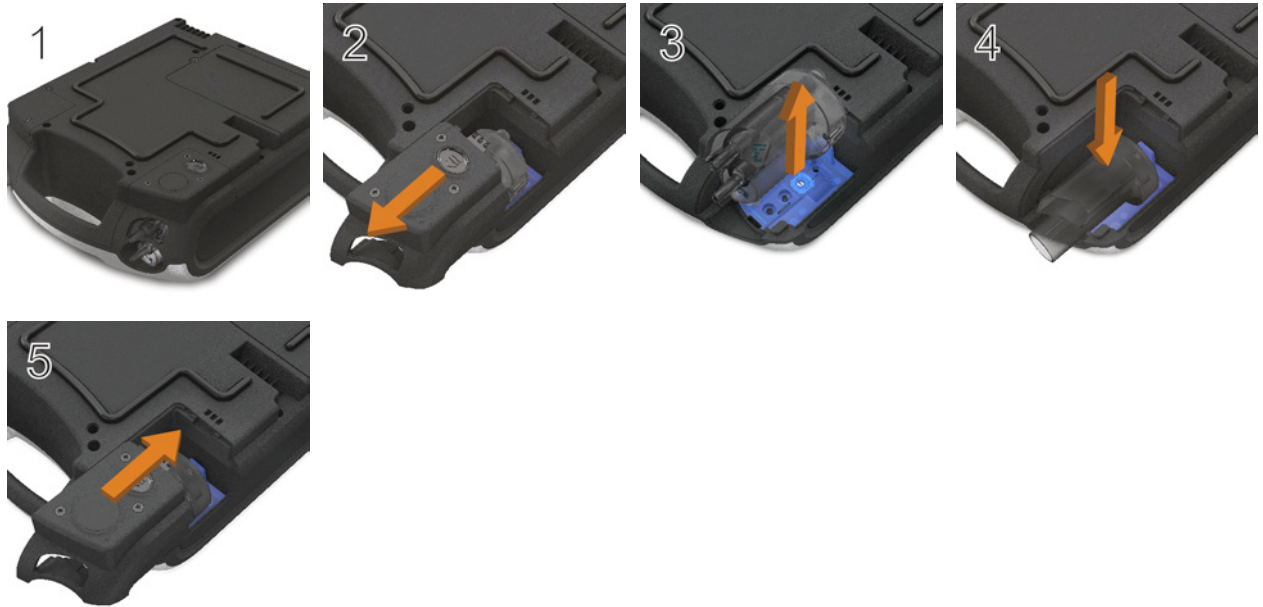

## Connecting a single limb circuit with intentional leak

An intentional leak may be provided in-line using the ResMed Leak Valve or via an integrated mask vent.

When using a circuit with intentional leak, estimation of the patient respiratory flow is enhanced by ResMed's automatic leak management feature—Vsync. Vsync technology allows the device to estimate the patient respiratory flow and tidal volume in the presence of unintentional leak.

### WARNING

- At low pressures, the flow through the mask vents may be inadequate to clear all exhaled gases, and some rebreathing may occur when using a single limb circuit with intentional leak.
- Ensure the vent holes at the mask or at the ResMed Leak Valve are unobstructed. Ensure the area around the vent holes is clear of bedding, clothes, or other objects and that the vents holes are not directed towards the patient.

To connect a single limb circuit with intentional leak:

1. Check the device is fitted with the single limb leak adapter. Otherwise, change the adapter.  
**Note:** The Astral 150 can also support a single limb circuit with intentional leak using a double limb adapter.
2. Connect the inspiratory limb to the inspiratory port.
3. Attach any required circuit accessories (eg, humidifier or filter).
4. Select the circuit type and perform a Learn Circuit.

## Assembling patient circuits

5. If using a non-vented mask or tracheostomy connector, attach a ResMed Leak Valve to the free end of the air tubing ensuring that the Leak Valve is as close as possible to the patient.
6. Attach the patient interface (eg, mask) to the Leak valve or the free end of the air tubing as appropriate and adjust the mask type setting on the Astral device.



## Connecting a single limb circuit for invasive use

### CAUTION

Always set up the ResMed Leak Valve in the breathing circuit with the arrows and the symbol pointing in the direction of air flow from the Astral device to the patient.



For invasive ventilation, since the patient's upper respiratory system is bypassed by an artificial airway device (for example endotracheal or tracheostomy tube) humidification of the inspired gas is required to prevent lung injury.

## Connecting a single limb circuit with expiratory valve

To enable fast and accurate connection, use an Astral Quick Connect Single Limb Circuit. This custom accessory with its integrated proximal pressure sensor and expiratory valve control line, is designed specifically for use with Astral ventilators.

**To connect an Astral 'Quick Connect' Single Limb Circuit with expiratory valve:**

1. Check the device is equipped with the single limb adapter (otherwise change the adapter).
2. Connect the air tubing to the inspiratory port on the device.
3. Attach the Astral Quick Connect circuit to the single limb adapter on the device (see diagram below).
4. Attach any required circuit accessories (eg, humidifier or filter).
5. Select the circuit type and perform a Learn Circuit.
6. Attach a patient interface (eg, mask) to the connector on the pneumatic valve.



## Assembling patient circuits

### To connect a standard single limb valved circuit to the Astral:

1. Connect the Proximal pressure line to the upper connector of the Astral device single limb adapter.
2. Connect the PEEP control line to the lower connector of the Astral device single limb adapter.
3. Connect the air tubing to the inspiratory port of the device.
4. Attach any required circuit accessories (eg, humidifier or filter).
5. Select the circuit type and perform a Learn Circuit.
6. Attach a patient interface (eg, mask) to the connector on the pneumatic valve.



## Connecting a double limb circuit (Astral 150 only)

The Astral device measures exhaled air flowing through the double limb circuit adapter. This enables patient-exhaled tidal volume to be accurately measured and monitored.

### To connect a double limb circuit:

1. Ensure the device is fitted with the double limb adapter (otherwise change the adapter).
2. Connect the ends of the air tubing to the inspiratory and adapter ports on the device.
3. Attach any required circuit accessories (eg, humidifier or filter).
4. Select the circuit type and perform a Learn Circuit.
5. Attach a patient interface (eg, mask) to the end of the air tubing.

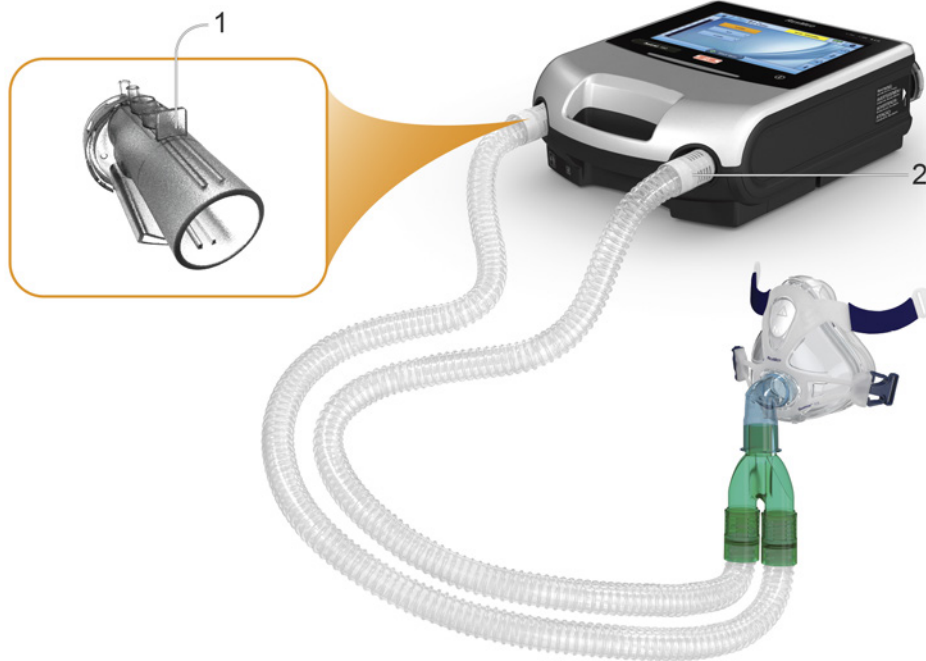

### Connecting a mouthpiece circuit

The mouthpiece circuit is a single limb circuit with no expiratory valve or intentional leak. This circuit is not intended to support continuous exhalation into the circuit. For patients that may prefer continuous exhalation into the circuit, a circuit with expiratory valve or intentional leak should be considered.

#### To connect a mouthpiece circuit:

1. Check the device is fitted with a single limb leak adapter. Otherwise, change the adapter.  
**Note:** The Astral 150 can also support mouthpiece circuit using a double limb adapter.
2. Connect the inspiratory limb to the inspiratory port.
3. Attach any required circuit accessories (eg, filter).
4. Select the circuit type and perform a Learn Circuit.
5. Attach the patient interface (eg, mouthpiece) to the free end of the air tubing as appropriate.





## Learn Circuit

In order to support a wide range of circuit configurations and accessories, the Astral device provides a Learn Circuit function to determine the characteristics of the circuit. As part of the Learn Circuit functionality the Astral performs a device self-test and a calibration of the FiO<sub>2</sub> sensor (if installed).

### CAUTION

To ensure optimum and accurate performance, it is recommended that the Learn Circuit function be performed with every change of circuit configuration and at regular intervals not less than once every three months.

Do not connect patient interfaces prior to performing the Learn Circuit. Patient interfaces include any components placed after the single circuit's expiratory valve or exhalation port, or double limb circuit's 'Y' piece (eg, HMEF, catheter mount, mask, tracheostomy tube).

To perform a Learn Circuit:

1. From the **Setup** main menu, select the **Circuit** sub-menu.
2. Press **Start** and follow the on-screen prompts.

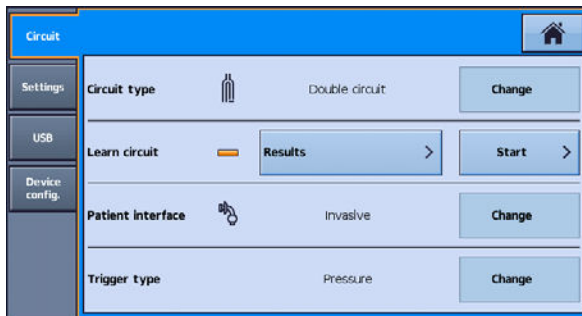

**Note:** Trigger type sets whether a pressure-based or flow-based trigger threshold is used when a Double circuit is selected.

The prompts will guide you through a number of steps including:

- With the patient interface disconnected from the patient connection port, the Astral device will characterise the impedance of the inspiratory path.
- With the patient connection port sealed, the Astral device will characterise the total circuit compliance, and then the impedance of the expiratory path.





After completing these steps, a test result screen is displayed. You can access this Results screen later using the Results button in the Circuit setting up screen.





## Assembling patient circuits

The following icons are used to report the Learn Circuit results:



### Learn Circuit Results

Icon	Description
	Learn Circuit completed
	Learn Circuit not tested. Default circuit characteristics will be applied. Accuracy of control and monitoring may not be met. Ensure that ventilation and alarms are effective before proceeding further.
	<p>Learn Circuit completed. Circuit resistance is high. The device will use the learned circuit characteristics. Accuracy of control and monitoring may not be met.</p> <p>If your clinician has configured your device with this circuit test result, then you may continue under the instruction of your clinician. However, if this is the first time you have seen this result, <b>check with you clinician whether it is safe for you use this circuit configuration.</b></p>
	<p>Learn Circuit has failed. Default circuit characteristics will be applied.</p> <p>Below are general steps to resolve the Learn Circuit issue. Refer to Learn Circuit Troubleshooting (see page 68) for suggested actions on the error code.</p> <ol style="list-style-type: none"><li>1. Inspect the circuit and proximal lines for disconnection or excessive leak.</li><li>2. Check that the circuit is correctly connected and matches the selected circuit type.</li><li>3. Check that the correct circuit adaptor is installed for the selected circuit type.</li><li>4. Check the module, the blue membrane and sensor are pressed all the way in and sit flush with the enclosure.</li></ol> <p>Accuracy of control and monitoring will be degraded. Ensure that ventilation and alarms are effective before proceeding further.</p>



### Device Test Results

Icon	Description
	Device Test has passed.
	Device Test has not been run. This only occurs on setting up a new therapy program.
	<p>Device Test has failed. Learn Circuit cannot be run.</p> <p>Below are general steps to resolve the Learn Circuit issue. Refer to Learn Circuit Troubleshooting (see page 68) for suggested actions on the error code.</p> <ol style="list-style-type: none"><li>1. Inspect the air inlet for foreign materials.</li><li>2. Inspect the air filter and replace it, if necessary. Refer to Cleaning and maintenance (see page 60) for further instructions.</li><li>3. Remove the expiratory module and inspect the module and blue membrane for any foreign materials.</li><li>4. Re-install the module, ensuring that it is securely in place.</li><li>5. Repeat Learn Circuit. If problem persists, refer to Learn Circuit Troubleshooting (see page 68) for suggested actions on the error code.</li></ol> <p>If you choose to proceed with ventilation, accuracy of control and monitoring will be degraded. Ensure that ventilation and alarms are effective before proceeding further.</p>

## Oxygen (FiO<sub>2</sub>) Sensor Results

Icon	Description
	Oxygen sensor calibration has passed.
	<p>Oxygen sensor not tested or not installed.</p> <ol style="list-style-type: none"> <li>1. If your device was supplied without an oxygen sensor, ignore this message and proceed with therapy.</li> <li>2. If possible, check that the oxygen sensor is securely attached as described in Replacing the oxygen sensor.</li> <li>3. Repeat Learn Circuit. If the oxygen sensor is still not detected, return the device for servicing by an authorised ResMed Service Centre.</li> </ol>
	<p>Oxygen sensor calibration has failed.</p> <p>Below are general steps to resolve the oxygen sensor calibration issue. Refer to Learn Circuit Troubleshooting (see page 68) for suggested actions on the error code.</p> <ol style="list-style-type: none"> <li>1. If possible, replace the oxygen sensor as described in Replacing the oxygen sensor.</li> <li>2. Repeat Learn Circuit. If problem persists, return the device for servicing by an authorised ResMed Service Centre.</li> </ol> <p>If you choose to proceed with ventilation, FiO<sub>2</sub> alarms will be disabled. An alternate method for monitoring FiO<sub>2</sub> is required.</p>

## Expiratory Flow Sensor Results

Icon	Description
	Expiratory flow sensor calibration has passed.
	Expiratory flow sensor not tested or not installed.
	<p>Expiratory flow sensor calibration has failed.</p> <p>Below are general steps to resolve the expiratory flow sensor calibration issue. Refer to Learn Circuit Troubleshooting (see page 68) for suggested actions on the error code.</p> <ol style="list-style-type: none"> <li>1. Remove the adapter, seal, and expiratory flow sensor.</li> <li>2. Inspect the module, seal, and flow sensor for any foreign materials.</li> <li>3. Re-install the module and flow sensor, ensuring that it is securely in place.</li> <li>4. If possible, replace the expiratory flow sensor as described in Replacing the expiratory flow sensor.</li> <li>5. Repeat Learn Circuit. If problem persists, return the device for servicing by an authorised ResMed Service Centre.</li> </ol> <p>If you choose to proceed with ventilation, check Vte and MVe alarms are effective.</p>

## Accessories

For a full list of accessories, see Ventilation accessories on [www.resmed.com](http://www.resmed.com) under the Products page. If you do not have internet access, please contact your ResMed representative.

### WARNING

---

Before using any accessory, always read the accompanying User Guide.

---

#### Helpful hint!

---

Only use accessories as directed by your clinician. Replace accessories according to the manufacturer's instructions.

---

## Power accessories

### WARNING

- The Astral device should only be used with accessories recommended by ResMed. Connection of other accessories could result in patient injury or damage to the device.
  - Connecting the Astral device to the battery of a battery-powered wheelchair may affect the device performance and may result in patient harm.
- 

The Astral device can be connected to a range of accessories as follows:

- Astral External Battery
- ResMed Power Station II
- Astral DC adapter
- ResMed Remote Alarm II
- Pulse Oximeter.

## Optional accessories

The Astral device can be used with a range of optional accessories as follows:

- Astral Mobility Bag
- Astral SlimFit Mobility Bag
- ResMed Homecare Stand
- Astral Table Stand
- Aerogen® nebuliser
- ResMed Connectivity Module (RCM)
- ResMed Connectivity Module for Hospital (RCMH).

**Note:** Some accessories may not be available in all regions.

## Attaching patient circuit accessories

### WARNING

- Adding or removing circuit components can adversely affect ventilation performance. ResMed recommends performing a Learn circuit every time an accessory or component is added to or removed from the patient circuit. If the circuit configuration is changed, the Disconnection Alarm needs to be checked for correct operation.
  - Do not use electrically conductive or anti-static air tubing.
-

## Attaching a humidifier

A humidifier or HME is recommended for use with the Astral device.

### WARNING

- For invasive ventilation, since the patient's upper respiratory system is bypassed by an artificial airway device (for example endotracheal or tracheostomy tube) humidification of the inspired gas is required to prevent lung injury.
- Always place the humidifier on a level surface below the level of the device and the patient to prevent the mask and tubing filling with water.
- Only use humidifiers that comply with the relevant safety standards, including ISO 8185 and set up the humidifier according to the manufacturer's instructions.
- Monitor the air tubing for water condensation and / or spillage from the humidifier. Use appropriate precautions to prevent water in the circuit transferring to the patient (eg, a water trap).

For non-invasive ventilation, for patient experiencing dryness of the nose, throat or mouth, humidification of the inspired gas will prevent subsequent irritation and discomfort.

### CAUTION

Make sure that the water tub is empty and thoroughly dried before transporting the humidifier.

To attach a humidifier to a patient circuit:

1. Connect a length of air tubing to the inspiratory port on the device.
2. Connect the other end of the air tubing to the inlet port on the humidifier.
3. Connect the patient circuit to the outlet port on the humidifier.

The image below shows proper use of a humidifier in combination with a double limb circuit.



When using heated humidification with a double limb circuit, condensation may form in the expiratory flow sensor if the air is cooled to below its dew point. Condensation may also form in the patient circuit and is most likely to form at high humidity settings and low ambient temperatures.

Condensation forming in the expiratory flow sensor may cause a loss of expiratory flow measurement and compromised therapy (ie, auto-triggering, increased PEEP and activation of the leak alarm).

To prevent condensation at the Expiratory flow sensor, always follow the humidifier manufacturer's instructions on how to prevent condensation and regularly check the patient circuit for condensation.

To ensure accurate therapy, Astral's Learn Circuit function should be performed prior to filling the water tub.

## Attaching a Heat Moisture Exchange (HME)

HME's are passive humidification systems that retain heat and moisture from the patient's exhaled gases via an internal membrane. An HME should not be used with active humidification. An HME can be used with the Astral device with a double limb circuit or single limb circuit with integrated valve.

### WARNING

---

Only use HMEs that comply with the relevant safety standards, including ISO 9360-1 and ISO 9360-2.

---

Place the HME between the patient end of the circuit and the patient interface.



Do not connect patient interfaces prior to performing the Learn Circuit. Patient interfaces include any components placed after the single circuit's expiratory valve or exhalation port, or double limb circuit's 'Y' piece (eg, HMEF, catheter mount, mask, tracheostomy tube).

## Attaching an antibacterial filter

### WARNING

- Regularly check the antibacterial filter and expiratory valve for signs of moisture or other contaminants, particularly during nebulisation or humidification. Failure to do so could result in increased breathing system resistance and/or inaccuracies in expired gas measurement.
- Only use antibacterial filters that comply with the relevant safety standards, including ISO 23328-1 and ISO 23328-2.

### CAUTION

---

The antibacterial filter must be used and replaced according to the manufacturer's specifications.

---

**To attach an antibacterial filter:**

1. Fit the antibacterial filter to the inspiratory port of the device.
2. Connect the air tubing to the other side of the filter.
3. Perform the Learn Circuit function.
4. Attach the patient interface to the free end of the air tubing.



**⚠ WARNING**

- To prevent the risk of cross-contamination, an antibacterial filter is mandatory if the device is to be used on multiple patients.
- The expiratory module, internal antibacterial filter, expiratory flow sensor and blue membrane come into contact with exhaled gases but do not form part of the inspiratory pathway.

**Adding supplemental oxygen**

Oxygen may be prescribed by your clinician.

The Astral device is designed to be compatible with levels of supplemental oxygen up to 30 L/min.

At a fixed rate of supplemental oxygen flow, the inhaled oxygen concentration will vary depending on the Ventilation mode and settings, patient breathing pattern, mask selection, and leak rate.



 **WARNING**

- Use only medical grade oxygen sources.
- Always ensure that the device is ventilating before the oxygen supply is turned on.
- Oxygen flow must be turned off when the device is not ventilating so that oxygen does not accumulate within the device enclosure. Explanation: Accumulation of oxygen presents a risk of fire. This applies to most types of ventilators.
- Oxygen supports combustion. Oxygen must not be used while smoking or in the presence of an open flame. Only use oxygen in well-ventilated rooms.
- Supplemental oxygen must be added into Astral's oxygen inlet at the rear of the device. Adding oxygen elsewhere, ie, into the breathing system via a side port or at the mask, has potential to impair triggering and accuracy of therapy/monitoring and impair alarms (eg, High Leak alarm, Non-vented mask alarm)
- The patient circuit and the oxygen source must be kept at a minimum distance of 2 m away from any sources of ignition.
- Monitor supplemental oxygen using the integrated FiO<sub>2</sub> sensor and alarms or use an external O<sub>2</sub> monitor compliant with ISO 80601-2-55.
- When operating Astral in its mobility bag do not add more than 6 L/min of supplemental oxygen.
- Astral is not designed for use with heliox, nitric oxide or anesthetic gases.
- Do not position the Astral device on its side as this may affect FiO<sub>2</sub> monitoring accuracy.

**To add supplemental oxygen:**

1. Unlock the low flow oxygen inlet at the rear of the device by pushing up on the locking clip.
2. Insert one end of the oxygen supply tubing into the oxygen port connector. The tubing will automatically lock into place.
3. Attach the other end of the oxygen supply tubing to the oxygen supply.
4. Start ventilation
5. Turn on oxygen and adjust (at the oxygen supply) to the prescribed flow rate or FiO<sub>2</sub> level.

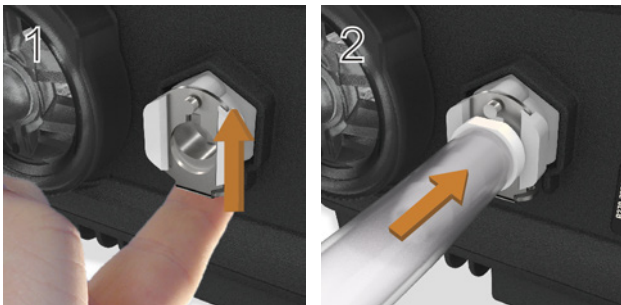

Supplemental oxygen can also be added from an oxygen bottle however, a flow regulator must be fitted to ensure the delivered oxygen remains at or below 30 L/min.

Before you remove supplemental oxygen from the device, ensure the Oxygen supply has been turned off.



**To remove supplemental oxygen:**

1. Unlock the low flow oxygen inlet at the rear of the device by pushing up on the locking clip.
2. Remove the oxygen port connector from the low flow oxygen inlet.

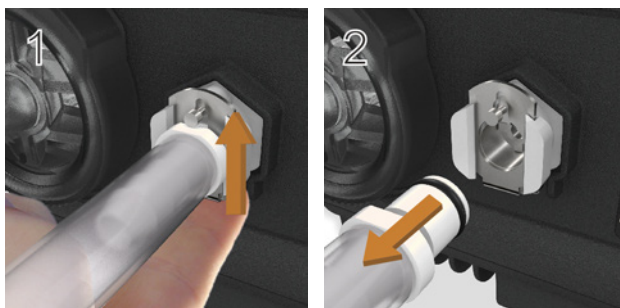
**Monitoring delivered oxygen**

The FiO<sub>2</sub> sensor is a standard inclusion on the Astral 150 and an optional accessory on the Astral 100. The sensor measures the average of percentage of oxygen delivered to the circuit through the inspiratory limb.

Prior to using the FiO<sub>2</sub> monitor, a Learn Circuit needs to be performed to calibrate the sensor. Repeat the calibration at regular intervals at least once every three months.

**Note:** It may take up to 30 minutes for the FiO<sub>2</sub> sensor readings to meet the specified accuracy after powering on the device from off state or when all power source indicators are off.

The FiO<sub>2</sub> sensor performance can be adversely affected by relative humidity, condensation on the sensor or unknown gas mixtures.

 **WARNING**

---

Do not position the Astral device on its side as this may affect FiO<sub>2</sub> monitoring accuracy.

---

**Attaching a nebuliser**

If required, a nebuliser can be used in conjunction with the Astral device. ResMed recommends Aerogen® nebuliser products—designed to operate in-line with standard ventilator circuits and mechanical ventilators without changing ventilator parameters or interrupting ventilation.

 **WARNING**

- 
- Always connect antibacterial filters to both the inspiratory port and the expiratory inlet of the Astral device to protect the device.
  - Regularly check the antibacterial filter and expiratory valve for signs of moisture or other contaminants, particularly during nebulisation or humidification. Failure to do so could result in increased breathing system resistance and/or inaccuracies in expired gas measurement.
  - Only operate the nebuliser when the device is ventilating. If ventilation is stopped, switch off the nebuliser.
  - Use of a gas jet nebuliser may affect ventilator accuracy. Monitor the patient and compensate for the gas volume introduced by the gas jet nebuliser as appropriate.
  - For full details on using a nebuliser, see the User Guide that comes with that device.
-

## Accessories

Connect the nebuliser unit with a T-piece into the inspiratory limb of the breathing circuit before the patient. If one of the Aerogen nebuliser models is being used (ie, Aeroneb Solo and Aeroneb Pro), it can be powered via the USB connector at the rear of the Astral device, or the Aerogen USB AC/DC adapter.



Pictured above: Aeroneb® Solo in-line.

For full instructions for use, please consult the Aeroneb Solo System Instruction Manual.

## Attaching other accessories

### Attaching a pulse oximeter

#### WARNING

- Only use compatible NONIN™ finger pulse sensors\*.
- Pulse oximeter sensors must not be used with excessive pressure for prolonged periods as this can cause patient pressure injury.
- The pulse oximeter sensor and cable needs to be verified for compatibility with Astral, otherwise patient injury can result.

#### CAUTION

Factors that may degrade pulse oximeter performance or affect the accuracy of the measurement include the following: excessive ambient light, excessive motion, electromagnetic interference, blood flow restrictors (arterial catheters, blood pressure cuffs, infusing lines, etc.), moisture in the sensor, improperly applied sensor, incorrect sensor type, poor pulse quality, venous pulsations, anemia or low hemoglobin concentrations, cardiogreen or other intravascular dyes, carboxyhemoglobin, methemoglobin, dysfunctional hemoglobin, artificial nails or fingernail polish, or a sensor not at heart level.

**To connect the pulse oximeter:**

1. Connect the plug of the finger pulse sensor to the plug of the pulse oximeter.
2. Connect the plug of the pulse oximeter to the SpO<sub>2</sub> (pulse oximeter) connector at the rear of the device.



\*Please refer to the Ventilation accessories on [www.resmed.com](http://www.resmed.com) under the Products page for part numbers of oximeter accessories with confirmed compatibility. For information on how to use these accessories, refer to the user guide that comes with these accessories.

Once you have attached the pulse oximeter, a message will briefly display in the information bar. Real-time SpO<sub>2</sub> and Pulse readings can be viewed from the Monitoring menu.

**Notes:**

- Values from the SpO<sub>2</sub> sensor are averaged over 4 heartbeats.
- Included SpO<sub>2</sub> sensor is calibrated for the display of functional oxygen saturation.
- The No SpO<sub>2</sub> monitoring alarm will activate if the pulse oximeter has been disabled or has a degraded signal for more than 10 seconds or has been disconnected.



### Attaching a remote alarm

The ResMed Remote Alarm II has been designed for use with Astral devices. The Remote Alarm II alerts you to an alarm that requires immediate attention. It triggers an audible and visual alarm when an alarm is triggered on the Astral device. For full instructions on using the Remote Alarm II, see the User Guide that comes with that device.

**To connect the Remote Alarm II to the Astral device:**

1. Connect one end of the alarm cable to the (3 pin) input connector on the remote alarm.
2. Connect the other end to the (5 pin) output connector located at the rear of the Astral device.



### CAUTION

---

To remove the cable, pull firmly on the connector. Do not twist.

---

## Power management

### Helpful hints!

---

- Connect the ventilator to the mains power whenever possible. In the event of battery failure, connect to mains power immediately to resume ventilation.
  - An external power source (Astral External Battery or RPSII) should always be available for ventilator-dependent patients.
  - An external power source (Astral External Battery or RPSII) should be in use in mobile situations, including when mains power is unavailable or disrupted. Do not rely solely on the internal battery for mobile use.
  - Ensure the external battery is sufficiently charged before using in mobile situations.
- 

### **WARNING**

---

- **Beware of electrocution. Do not immerse the device, power supply or power cord in water.**
  - **Make sure the power cord and plug are in good condition and the equipment is not damaged.**
  - **Keep the power cord away from hot surfaces.**
  - **Explosion hazard—do not use in the vicinity of flammable anesthetics.**
- 

The Astral device can be used with different power sources:

- Mains power
- Astral External Battery
- External DC power supply (eg, car 12V power outlet)
- ResMed Power Station II
- Internal battery

For information on power supplies and sources, refer to the Technical Specifications (see page 72).

## Connecting to mains power



---

Ensure that the power cord does not pose a tripping or choking hazard.

---

### To connect to mains power:

1. Connect the DC plug of the supplied ResMed external power supply unit to the rear of the Astral device.
2. Before connecting the power cord to the ResMed power supply unit, ensure the end of the connector of the power cord is correctly aligned with the input socket on the power supply unit.
3. Plug the other end of the power cord into the power outlet.



**Note:** The power cord is equipped with a push-pull locking connector. To remove, grasp the power cord housing and gently pull the connector from the device. Do not twist its outer housing or pull on the cord.



## Connecting the Astral External Battery

The Astral External Battery has been designed specifically for use with the Astral Series of ventilators. It is intended to provide Astral ventilators with eight hours of power during typical use.

For full details on using the Astral External Battery, refer to the External Battery user guide.



### Using the External Battery

Connecting a fully charged External Battery to the Astral device can provide 8 hours of power during typical use. A second fully charged External Battery can be connected to the Astral device to provide a further 8 hours of power during typical use. A maximum of two external batteries can be connected to the Astral device.

Once the External Battery is connected to the Astral device, the DC mains indicator on the user interface will illuminate.

### WARNING

- Do not attempt to connect more than two external batteries. Battery specific messages and alarms on the Astral device will not operate for any additional units.
- In the unlikely event of an issue occurring with the external battery, Astral will sound an alarm and notify the user indicating that the device is operating on internal battery power. Ventilation will continue, however, users should connect to an alternative external power source (eg, AC power or another external battery) as soon as possible.

Alarms and messages relating to the External Battery may occur from time to time. All message information will be displayed on the Astral user interface, and will be accompanied by an audible signal. Refer to the Alarms Troubleshooting (see page 64) for further information.

## Connecting to a ResMed Power Station (RPSII)

The RPSII provides the Astral device with eight hours of power during typical use. To use, connect the power cord of the RPSII to the DC inlet port on the device.

### CAUTION

- 
- When using the Astral device with an RPSII, the internal battery will not be charged.
  - Do not use the RPSII and external battery together.
- 



## Connecting to an external DC power source

### CAUTION

- 
- When using a car auxiliary adapter, start the car before plugging in the device's DC adapter.
  - If the external DC power source drops to below 11V, the Astral will switch to internal battery.
  - When the device is turned off while connected to the DC adapter, it will continue to draw power from the external DC power source.
- 

To connect DC power:

1. Connect the DC plug of the external DC power supply unit to the rear of the device.
2. Plug the other end of the power cord into the power outlet.





## Using the internal battery

An internal battery is included in the Astral device. It ensures a continuous power supply when mains power is disrupted and no external battery is connected to the device. When the Astral starts using the internal battery as its power source, you are notified by the **Using internal battery** alert and with the internal battery power source indicator.

The internal battery operates for approximately eight hours under typical conditions. During ventilation, alarms will alert the user to a low battery condition. During standby, no alarms will be announced. The user should regularly check the battery status.

### WARNING

- 
- When using the Astral device as a backup ventilator, ensure the internal battery level is checked on a regular basis.
  - As the battery ages, the available capacity decreases. When the remaining battery capacity is low, do not rely on the internal battery as the primary power supply.
  - The internal battery should be replaced every two years or sooner when there is a noticeable reduction in usage time when fully charged.
  - The internal battery is not intended to serve as a primary power source. It should only be used when other sources are not available or briefly when necessary; for example, when changing power sources.
- 

### CAUTION

- 
- Revert to AC mains power when the remaining capacity of the battery is low.
  - The internal battery may stop charging when ambient temperatures of 35°C or more are reached. This will be indicated with a Power fault/No charging alarm message.
  - The internal battery will be depleted if the device is left in storage for an extended period of time. During storage, ensure the internal battery is recharged once every six months.
  - Storing the Astral device at temperatures exceeding 50°C for extended periods will accelerate battery ageing. This will not affect the safety of the battery or the device.
- 

While connected to mains power, the internal battery continues to charge when the device is operating or in standby.

For more information on the expected operating time of the internal battery, see the Technical Specifications.

### Battery run time

The internal battery powers the Astral device for eight hours under conditions typical to the chronic home ventilator-dependent patient.

Internal battery run time is determined by the:

- percent charge
- environmental conditions (such as temperature and altitude)
- condition and age of the battery
- device settings
- patient circuit setup and unintentional leak.

The internal battery should be replaced every two years or sooner when there is a noticeable reduction in usage time when fully charged.

### Storing and recharging

If the internal battery is not used, it must be recharged every six months.

## Accessories

It takes approximately four hours to fully recharge the internal battery from depletion; however this can vary depending on environmental conditions and the device operating state.

### To prepare the internal battery for long-term storage:

1. Check that the battery charge level is between 50 and 100%. If not, charge the device to at least 50% prior to storage.
2. Remove the power cord from the Astral.
3. Turn off the device.

### To recharge the internal battery:

1. Connect the device to mains power.
2. Charging commences as indicated by a flashing battery charging indicator symbol in the Information bar.

### Notes:

- When charging a completely depleted battery, it will normally take up to 30 minutes to increase battery capacity from 0% to 1%.
- If the device has been stored outside the operating temperature range, an alarm message (**Power fault / No charging**) may appear. You can still continue using the device, however, if the alarm persists for more than 2 hours the battery may need replacement.

## Device power source indicators



Information on system and battery charge levels can be accessed in one of two ways:

### 1. Battery Indicator

The capacity of all connected batteries will be added to the RunTime indicator on the Information bar of the Astral interface. (This may take a couple of minutes). The total will be the sum of the Astral internal battery plus either one or two external batteries.

Under normal operating conditions, the ventilator will display:

- Total system state of charge as a percentage when in ventilation standby mode or connected to mains power.
- Estimated remaining run time while delivering therapy.

Display	Description
	When either the external or internal battery is in use, but the device is not ventilating, the battery charge level is displayed. The battery percentage is an average of all batteries connected to the system. Full details of individual battery capacities can be reviewed in the Battery information page.
	When either the external or internal battery is in use during ventilation, the remaining usage is displayed as estimated by current operating conditions. The total will be the sum of all batteries connected to the system.
	When either the external or internal battery is charging, the charge battery symbol and percentage charged is displayed.

**Note:** Only the Astral external and internal batteries are included in battery indicator calculations. RPSII battery levels are not displayed.

### 2. Battery information

The battery information can be accessed from the Battery sub-menu in the Information menu. This menu has two tabs:

- Charge—displays the current charge level (0-100%) for any batteries currently detected by the system, as well as the total system charge.
- Maintenance—displays the full charge capacity and the charge cycle count for any batteries currently detected by the system.

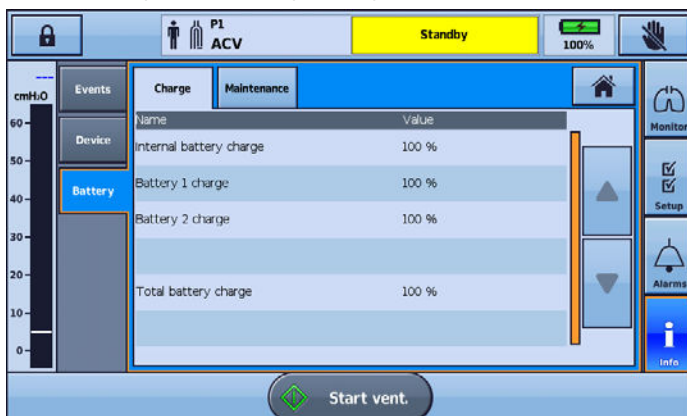

Regularly check the charge level of the internal battery and any connected external batteries. It is recommended to replace any batteries at 400 charge cycles.

## Astral Carry Bag

The Astral device should always be packed in its Carry Bag when not in use to prevent damage to the device.

### WARNING

---

The Astral should not be operated while in the Carry Bag. To ventilate while travelling, use the Astral Mobility bag or SlimFit mobility bag.

---

#### To use the Carry Bag

1. Prior to placing the device in the Carry Bag, remove:
  - the power connection from the rear of the device
  - all patient circuit components
  - all accessories, including Remote Alarm and oximeter
  - the USB Stick.
2. Place the Astral device carefully into the Carry Bag, ensuring the handle is at the top and the screen faces the printed image on the bag.
3. Secure the Astral device in place by using the Velcro strap. (To ensure the most secure position, thread the Velcro strap through the handle and attach.)
4. Place the Power Supply unit and any heavy components in the side zippered pocket.
5. Ensure all zippers are completely closed and the device secure before lifting the Carry Bag.

### CAUTION

---

Do not place any heavy or bulky objects in the zippered pocket on the inside front of the bag. This could result in damage to the LCD Touch screen.

---





## Alarms

The Astral device activates alarms to alert you to conditions that require attention to ensure patient safety. When an alarm is activated, the Astral device provides both audible and visual alerts, and displays an alarm message in the Alarm display on the Information bar.

As part of the alarm system (eg, the overpressure protection and system alarms), Astral may perform an automatic restart. An automatic restart checks systems and ensures correct operation of the alarm.

As soon as the activation condition is met, the Astral device provides both audible and visual alerts without delay.





Indicator	Description
1	<p>Alarm display</p> <p>Displays either the alarm message for the highest priority active alarm, or the last alarm not yet reset.</p> <p>Press the Alarm display for further alarm information.</p> <p>Certain conditions may result in multiple alarms.  indicates that there are multiple active alarms. Press  when displayed to view all alarms and respond appropriately. Alarms are displayed in order of priority.</p>
2	<p>Active Alarms screen</p> <p>Displays the full set of active alarms. Will automatically display upon activation of an alarm in Patient mode.</p>
3	<p>Information menu</p> <p>Some alarms clear automatically. To view a history of alarms, view the alarm log through the Information menu.</p>

## Alarms

	Indicator	Description
4	Alarm mute/reset button	State: <ul style="list-style-type: none"><li>no light – no active alarms</li><li>steady light – active alarm/s</li><li>flashing light – alarm mute on.</li></ul> This button also allows you to: <ul style="list-style-type: none"><li>mute the audible alert</li><li>reset the currently displayed alarm (if permitted).</li></ul>
5	Alarm bar	Indicates the priority of the alarm in the Alarm display.

## Alarm priority

Alarms are classified into relative priority (high, medium and low) according to the severity and urgency of the alarm condition. Respond to all alarms. An immediate response is required for high priority alarms.

Alarm priority		Alarm bar	Audible alert
High		Red flashing light	10 beeps every 5 seconds
Medium		Yellow flashing light	3 beeps every 15 seconds
Low		Yellow steady	2 beeps every 25 seconds

### Helpful hint!

For suggestions on resolving most common alarms, refer to Alarms Troubleshooting.

The following list of alarms is ordered by relative importance within priority.

High priority alarms	Medium priority alarms	Low priority alarms
Total power failure*	High pressure	Using internal battery
High pressure protection	Low PEEP	Battery 1 fault
Circuit disconnection	High PEEP	Battery 2 fault
Low Pressure	Low pulse rate	Power fault/No charging
Obstruction	High pulse rate	PEEP blower failure
High Pressure	Device overheating	
Apnea	Pressure line disconnected	
Low MVe	Last self test failed	
Low MVi	Flow sensor not calibrated	
High MVi	No SpO <sub>2</sub> monitoring	
High MVe	No FiO <sub>2</sub> monitoring	
Low Vte	Internal battery degraded	
High Vte	Low internal battery	
Low Vti	Circuit fault	
High Vti		
Low Resp. rate		
High Resp. rate		
High leak		
Ventilation stopped		
Low SpO <sub>2</sub>		
High SpO <sub>2</sub>		
Low FiO <sub>2</sub>		
High FiO <sub>2</sub>		
NV mask/Rebreathing		
Incorrect circuit adapter		
Critically low battery		
Incorrect circuit attached		
Safety reset complete		
Battery inoperable		

\*No LED will flash during a Total power failure alarm.

## Viewing the active alarms

 in the Alarm display indicates that there are multiple active alarms. Although multiple alarms can be active simultaneously, the Alarm display only shows the highest priority alarm. The full set of active alarms is displayed in the Active alarms screen.

When the highest priority alarm is cleared, the next highest priority alarm displays in the Alarm display.



### To view the active alarms:

1. From any screen, press the Alarm display on the Information bar. The Active alarms screen is displayed. This screen contains a full list of currently active alarms, displayed in order of their relative priority.
2. Press **OK** to close the Active alarms screen and return to the previous screen.



## Muting alarms

You can temporarily mute the audible alert on the Astral device for a two minute period. The Alarm display and Alarm bar continue to display the alarm as usual. If after two minutes the alarm condition is still present, the audible alert will sound again.

You can also use the Alarm Mute in advance, to 'pre-silence' alarms that you expect to occur. This can be helpful during suctioning procedures or when intending to disconnect the patient from the ventilator for a short period.





### To mute the audible alert on an active alarm:

Press .

The alarm is silenced for two minutes. During that period,  is displayed on the Information bar and  flashes.

**Note:** Pressing the Alarm mute/reset button again during the Alarm Mute period will reset the displayed alarm. Refer to Resetting alarms (see page 53).

### To silence alarms before they activate:

1. Press . Alarm mute is active for two minutes. During that period,  is displayed on the Information bar and  flashes.
2. To cancel Alarm mute, press the flashing  again.



**Helpful hint!**

You can adjust the volume of the audible alert. For information, refer to Device settings. After any adjustment, make sure you can still hear the alarm clearly from a distance.

**Resetting alarms**



Resetting an alarm removes that alarm from the Alarm display and the Active alarms screen, and turns off the visual and audible alerts. An active alarm should only be reset after the situation that caused the alarm has been attended to. If the alarm condition has not been corrected, the alarm will activate again.

The Astral device may automatically clear an alarm when the condition that triggered the alarm is corrected. When an alarm is cleared it no longer displays in the Active alarms screen and the audible and visual alerts cease.

When an alarm is cleared or manually reset, the Alarm display then shows the next highest priority active alarm.

Some alarms cannot be manually reset. For these alarms you must correct the cause of the alarm. Resolving the alarm will automatically clear the display.

**To reset the displayed active alarm:**

1. Press  to mute the alarm. The button illuminates and flashes.
2. Press  again to reset the alarm. The alarm message is removed from the Alarm display. It is also cleared from the Active alarms screen.

**Note:** You can carry out this procedure with the Active alarms screen open, if you want visibility of all the active alarms as you perform the reset.

**To reset all active alarms:**

1. Press the Alarm display on the Information bar. The Active alarms screen is displayed.



2. Press **Reset all** to reset multiple alarms. Only those alarms that can be reset, will be reset. Any remaining alarms will require user intervention and correction.
3. Complete any required action to resolve the remaining alarms.
4. Press **OK** to close the Active alarms screen and return to the previous screen.

**Adjusting the alarm volume**

The volume level of the Astral device can be set from one to five (with five being the loudest and the default being three). Your Clinician has pre-set a minimum volume level. Any settings below the set minimum are greyed out and are disabled from use.

## WARNING

- Alarm volume cannot be adjusted separately for individual alarms. Adjusting the alarm volume will change the volume of all alarms, independent of alarm priority level.
- When adjusting alarm volume, ensure that the alarm can be heard above the ambient noise levels that the patient may experience in a variety of settings, including use in noisy environments or inside mobility bags.

In the example below, your Clinician has maintained the default alarm volume of three. This means the '1' and '2' volume options are disabled and you are free to increase and decrease the alarm Volume levels between '3' and '5'. If however, your Clinician had set the minimum volume level at '1', all volume options would be available for selection.

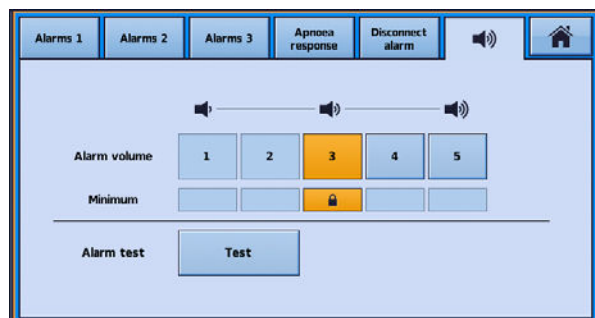



## Testing the alarm sounders and indicators

To confirm the alarm will sound as intended, regularly test the alarm.

The Astral device incorporates two alarm sounders. During an alarm condition both sounders are operated in parallel. To confirm the correct operation of each sounder, regularly perform the Alarm test function. During this test each sounder will be operated separately and in sequence.

To test the alarm sounders and indicators:

1. Press . The Alarms screen is displayed.
2. Press . The Alarm volume screen is displayed.

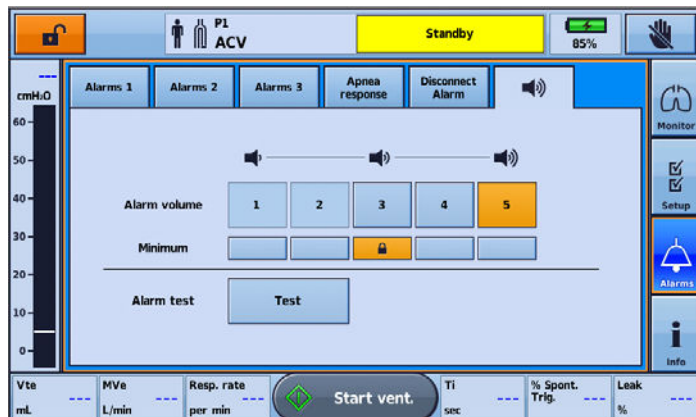

3. Press **Test** to test the alarm. The alarm beeps **twice** and the LED flashes to indicate it is working correctly. Confirm the alarm beeps twice. Confirm the Alarm bar flashes red, then yellow. Confirm the mute button flashes.

## WARNING

If no alarm sounds, do not use the ventilator.

## CAUTION

If only one beep is heard, or the Alarm bar does not flash red, then yellow, return the device for servicing.

## Testing the Remote Alarm

The Remote Alarm generates an audible and visual signal when an alarm is triggered on the ventilator.

## CAUTION

A test of the Remote Alarm should be performed prior to initial use and every change of battery. Test the alarm periodically as per the facility policy. For dependent patients perform a test on a daily basis.

To test the Remote alarm, press  on the Remote Alarm.

The following will occur:

- The alarm LED illuminates and the alarm sounds.
- The LED corresponding to the set volume illuminates.
- The Disconnect LED blinks if the alarm is not connected to the device and lights permanently if connected.
- The battery level LED corresponding to the battery level illuminates. Yellow LED if battery life is low, or green LED if battery life is good. (Replace the battery if the battery life is low).
- If a second Remote Alarm is connected, the second Remote Alarm will also sound.

## Testing the alarms

## WARNING

Do not perform alarm tests while the patient is connected to the ventilator.

This section describes functional tests to allow the user to understand the conditions that can trigger common Astral alarms. The efficacy of therapy alarm limits should be assessed by your clinician.

**Note:** In some alarm test procedures multiple alarms will be triggered. To see all of the active alarms, press the Alarm display button as described in the Viewing the active alarms (see page 52).

## CAUTION

When the alarm tests are completed ensure the Astral device is restored to its original state and the internal battery is charged.

Alarm	Test procedure
Low Pressure	<ol style="list-style-type: none"> <li>1. Disconnect the patient interface from the circuit.</li> <li>2. Start ventilation.</li> </ol>
Low Vte (Only possible on Double limb and Single limb with intentional leak circuits)	<ol style="list-style-type: none"> <li>1. Disconnect the patient interface from the circuit.</li> <li>2. Start ventilation.</li> </ol>
Obstruction	<ol style="list-style-type: none"> <li>1. Disconnect the patient interface from the circuit.</li> <li>2. Start ventilation.</li> <li>3. Block the circuit outlet.</li> </ol>

## Alarms

High leak (Only possible on Double limb and Single limb with intentional leak circuits)	<ol style="list-style-type: none"><li>1. Disconnect the patient interface from the circuit.</li><li>2. Start ventilation.</li></ol>
Low FiO <sub>2</sub> (Only possible to test if the therapy has been configured for supplemental oxygen use)	<ol style="list-style-type: none"><li>1. Turn off the supplemental oxygen.</li><li>2. Start ventilation.</li></ol>
High FiO <sub>2</sub> (Only possible to test if the therapy has been configured for supplemental oxygen use)	<ol style="list-style-type: none"><li>1. Adjust supplemental oxygen to a higher flow rate.</li><li>2. Start ventilation.</li></ol>
Using internal battery	<ol style="list-style-type: none"><li>1. Ensure the Astral device is connected to an external power source.</li><li>2. Power on the Astral device.</li><li>3. Disconnect the power cord.</li></ol>
Low battery Critically low internal battery	<ol style="list-style-type: none"><li>1. Ensure the Astral device is powered on and is operating on the internal battery.</li><li>2. Go to the <b>Setup</b> menu and select <b>Device Config</b>. Turn off the <b>Auto power off</b> and <b>Backlight timeout</b> settings. Refer to Adjusting device settings (see page 19).</li><li>3. Wait for the internal battery to run flat. This will take over 10 hours from a fully charged internal battery.</li></ol>

## Power alarms



### CAUTION

Data cannot be saved while there is a Critically low battery or Battery inoperable alarm. Program selections made while these alarms are active may be lost if the device is restarted. Recording of ventilation data and alarms is suspended.

Alarm	Activates when
Low internal battery	Approximately 20 minutes of ventilation time remaining on internal battery power.
Critically low battery	Approximately 10 minutes of ventilation time remaining on internal battery power.
Total power failure	There is total loss of power due to failure of the internal battery, or a loss of external power while the internal battery is removed or fully depleted/discharged.
Power disconnected	The power source is changed from an external source to the internal battery.
Using internal battery	The Astral device is powered on and is using battery power.
Battery inoperable	The internal battery is faulty or has been removed.
Internal battery degraded	The internal battery is degraded and may not provide a reliable indication of remaining time.

## Detecting circuit disconnection and de-cannulation

Inadvertent disconnection of a circuit component or accidental removal of a cannula poses a hazard to a dependent patient. Astral is equipped with a number of alarms that when used in conjunction with the Disconnection Alarm are able to reliably detect circuit disconnection (including de-cannulation).

The optimal alarm may depend on the therapy target and circuit type as shown in the table below.

However, Astral provides a number of alarms that can be configured by your clinician specifically for this purpose.

### WARNING

Alarm settings are sensitive to any changes to the circuit, ventilation settings or co-therapy. Test the effectiveness of the alarm after any of these changes are made.

### CAUTION

Alarms should be configured and tested to ensure that circuit disconnection and de-cannulation is detected. We recommend configuring and testing multiple alarms and testing disconnection at the ventilator and at the cannula. Independent monitoring can be used as an alternative.

The following table provides the most appropriate alarms for use in detecting circuit disconnection.

	Pressure target modes	Volume target modes
Single with leak	Disconnection alarm Low pressure alarm Low Vte alarm Low MVe alarm Apnea alarm Leak alarm SpO <sub>2</sub> alarm	N/A
Single with valve	Disconnection alarm Low pressure alarm Low Peep alarm High Vti alarm High MVi alarm Apnea alarm SpO <sub>2</sub> alarm	Disconnection alarm Low pressure alarm Low PEEP alarm Apnea alarm SpO <sub>2</sub> alarm
Double with valve		Disconnection alarm Low pressure alarm Low Vte alarm Low MVe alarm Apnea alarm Leak alarm SpO <sub>2</sub> alarm
Mouthpiece	Disconnection alarm Low pressure alarm High Vti alarm High MVi alarm Apnea alarm SpO <sub>2</sub> alarm	Disconnection alarm Low pressure alarm Apnea alarm SpO <sub>2</sub> alarm

### Astral Disconnection Alarm

The Astral Disconnection Alarm constantly measures circuit resistance to detect disconnection during therapy. The high priority Disconnection Alarm will activate when the device detects a disconnection that persists continuously for more than the alarm Activation Time preset by your clinician. If the degree of disconnection is resolved within this time, the Alarm Activation Time will be reset.

### Adjusting the Disconnection Alarm

Your clinician can adjust the Disconnection Alarm to suit your needs. Your clinician can:

1. Adjust alarm Activation Time – the time it takes (in seconds) following disconnection for the alarm to activate
2. Adjust Disconnection Tolerance – the degree of disconnection that it takes to activate the alarm
3. Turn the Disconnection Alarm On/ Off.



**Note:** The Disconnection Alarm default setting is On.

#### To test the Disconnection Alarm:

These steps should be performed prior to connecting patient to the ventilator.

1. Attach all components of the patient circuit, including interface (a test cannula should be used in the case of a tracheostomy).
2. Start ventilation at the appropriate therapy settings, circuit configuration, and supplemental oxygen (if required).
3. Check that the measured disconnection value turns red and that the Disconnection Alarm activates after the Alarm Activation Time.

**Note:** If the Disconnection Alarm does not sound, the alarm parameters may need to be adjusted by your clinician.

#### Helpful hint!

De-cannulation can be the most difficult disconnection for the device to detect. To ensure de-cannulation is detected, test the Disconnection Alarm using a test cannula. Your clinician can help you to do this.

## Data management process

Monitoring data from the Astral device can be viewed in the ResScan™ patient management software. Data is transferred from the device to ResScan using a USB stick. Once downloaded to ResScan, the data can be viewed in several report formats to easily monitor treatment results and compliance.

### To connect the ResMed USB to the Astral device:

Plug a USB stick into the USB connector at the rear of the device. The  symbol is displayed in the Information bar to indicate the USB is attached.



To remove the USB stick, simply pull it out of the USB connector on completion of transfer. If data was being transferred at the time, a message in the Information bar alerts you to a failed transfer.

### WARNING

Only connect devices specially designed and recommended by ResMed to the data communication ports. Connecting other devices could result in patient injury, or damage to the Astral device.

### To transfer data:

1. From the **Settings** menu select **Patient Data** from the **USB** sub-menu.
2. Press **Save >**. When the transfer is complete a status message is displayed.

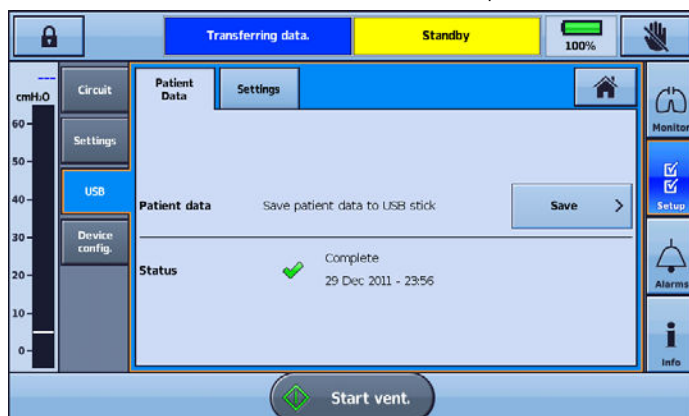

3. Press **Clear** to acknowledge you have read the message and enable further transfers.
4. Remove the USB stick from the Astral device.
5. At the computer where ResScan is installed, plug the USB stick into the USB port.
6. Follow the download procedure specified in the ResScan User Guide.

## Cleaning and maintenance

The cleaning and maintenance described in this section should be carried out regularly.

Refer to the user guides for the patient interface, humidifier and other accessories in use for detailed instructions for care and maintenance of those devices.

### WARNING

- A patient treated by mechanical ventilation is highly vulnerable to the risks of infection. Dirty or contaminated equipment is a potential source of infection. Clean the Astral device and its accessories regularly.
- Always turn off and unplug the device before cleaning and be sure it is dry before plugging back in.
- Do not immerse the device, pulse oximeter or power cord in water.

### CAUTION

Clean only exterior surfaces of the Astral device.

When required, wipe the exterior of the device with a damp cloth using an approved mild cleaning solution.

For all circuit components, follow the manufacturer's recommendations for cleaning and maintenance.

## Weekly

1. Inspect the condition of the circuit adapter for entry of moisture or contaminants. Replace as necessary.
2. Test the alarm sounders, refer to Testing the alarm sounders (see page 54).

### Helpful hint!

For information on removing and replacing the circuit adapter, refer to Fitting the circuit adapter (see page 23).

## Monthly

1. Inspect the condition of the air filter and check whether it is blocked by dirt or dust. With normal use, the air filter needs to be replaced every six months (or more often in a dusty environment).
2. Check the charge level of the internal battery by:
  - removing external power and operating the device on internal battery for a minimum of 10 minutes.
  - reviewing the remaining battery capacity, refer Using the Internal battery (see page 45).
  - restoring external power once the test is complete.

### To remove and replace the air filter

1. Unlock the air filter cover by turning in an anti-clockwise direction.
2. Pull the air filter cover from the device.
3. Pull the air filter from the cover and discard.
4. Insert a new filter into the cover.
5. Insert the air filter and cover back into the device.
6. Turn in a clockwise direction to secure in place.



## Servicing

### WARNING

Inspection and repair should only be performed by an authorised agent. Under no circumstances should you attempt to service or repair the device yourself. Failure to do so could void your Astral device warranty, damage the Astral device or result in possible injury or death.

Note: Retain the original packaging of the Astral device for use when shipping to/from an authorised ResMed Service Centre.

### WARNING

- To prevent the risk of cross-contamination, an antibacterial filter, placed on the inspiratory port is mandatory if the device is to be used on multiple patients as under some fault conditions, expired gas may be returned through the inspiratory port.
- The expiratory module, internal antibacterial filter, expiratory flow sensor and blue membrane come into contact with exhaled gases but do not form part of the inspiratory pathway.

## Replacing the air filter

Inspect the condition of the air filter and check whether it is blocked by dirt or dust. With normal use, the air filter needs to be replaced every six months (or more often in a dusty environment).

### CAUTION

Do not wash the air filter. The air filter is not washable or reusable.

#### To remove and replace the air filter

Before replacing the air filter, turn off the device and remove mains power and/or external battery.

1. Unlock the air filter cover by turning in an anti-clockwise direction.
2. Pull the air filter cover from the device.
3. Pull the air filter from the cover and discard.
4. Insert a new filter into the cover.
5. Insert the air filter and cover back into the device.
6. Turn in a clockwise direction to secure in place.

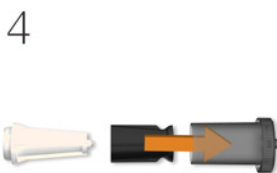
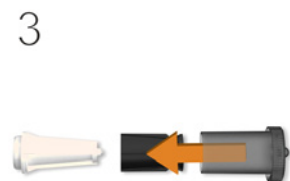

## Cleaning and maintenance

### Maintenance Timetable

The Astral device should be serviced by an authorised ResMed Service Centre according to the following schedule. The Astral device is intended to provide safe and reliable operation provided that it is operated and maintained in accordance with the instructions provided by ResMed. As with all electrical devices, if any irregularity becomes apparent, you should exercise caution and have the device inspected by an authorized ResMed Service Centre.

With regular servicing, the expected service life of an Astral device is 8 years.

Servicing schedule from the date of first use:

Recommended service interval	Conducted by	Instructions
Every six months	Personnel who have been trained in the use of Astral	Replacement of the air filter (replace earlier if dirty). Replacement of Single or Double limb circuit adapters if used.
Two years	Qualified technician	Two year Preventative maintenance. Replacement of the internal battery and FiO <sub>2</sub> sensor if fitted.
35,000 hours	Qualified technician	Pneumatic block Preventative maintenance.

#### Helpful hint!

If Service Reminders are enabled you will get a notification on the device when two year preventative maintenance is nearly due.

### Internal Battery

The expected life of the internal battery is two years. The internal battery should be replaced every two years or sooner when there is a noticeable reduction in usage time when fully charged. During storage ensure that internal battery is recharged once every six months.

#### Helpful hint!

If Service reminders are enabled you will get a notification on the device when there is a measurable reduction in battery usage time.

## Device information

Device information, including the Next service due date indicating when the next preventative maintenance is due, can be found by pressing **i** and selecting Device.

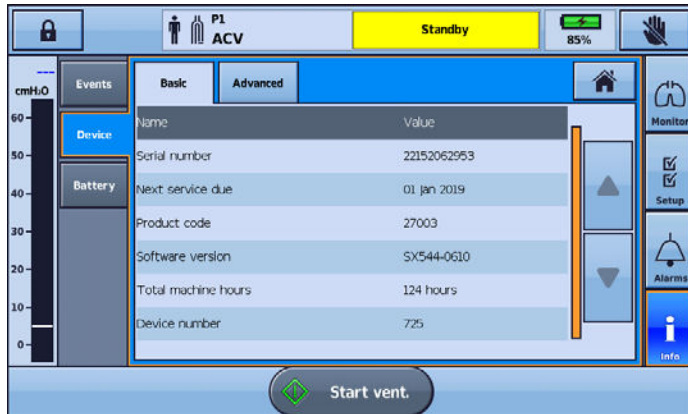

## Troubleshooting

If there is a problem, try the following suggestions. If the problem cannot be solved, contact your care provider or ResMed.

### Alarm troubleshooting

The most common reason for an alarm to sound is because the system has not been properly assembled or a Learn Circuit has not been correctly performed for each program.

**Notes:**

- The alarm actions listed below are based on having the appropriate alarm settings for the patient's therapy. When an adjustable alarm is activated, re-confirm the alarm settings.
- The alarm log and alarm settings are maintained when the device is powered down and in the event of a power loss.
- If an alarm activates repeatedly, discontinue use, switch to a backup ventilator and return the device for servicing.

If the alarm log reaches its storage capacity, the oldest data will be discarded to allow new entries to be written to the log.

Alarm message	Action
Apnea	<ol style="list-style-type: none"> <li>1. Check the patient's status and airway.</li> <li>2. Inspect the circuit and proximal lines for leak. Perform a Learn Circuit.</li> </ol>
Battery 1 fault	Check battery connections. If problem persists replace External Battery 1 with new external battery.
Battery 2 fault	Check battery connections. If problem persists, replace External Battery 2 with a new external battery.
Battery Inoperable	<ol style="list-style-type: none"> <li>1. If the device has been stored in extreme temperatures, wait until the device returns to room temperature.</li> <li>2. If the device has been stored for long periods of time, the battery may have discharged. Connect to mains power.</li> <li>3. If alarm persists, return the device for servicing.</li> </ol>
Circuit fault	<ol style="list-style-type: none"> <li>1. Check the circuit for water or leaks.</li> <li>2. Perform a Learn Circuit.</li> <li>3. If the alarm persists, replace the circuit.</li> </ol>
Critically low battery	Connect the Astral to mains AC power and allow the battery to recharge.
Device overheating	<ol style="list-style-type: none"> <li>1. Move the device to a cooler location.</li> <li>2. Inspect the air inlet for foreign objects.</li> <li>3. Inspect the air inlet filter. If necessary, replace the air inlet filter.</li> <li>4. Inspect the cooling fan inlet and outlet for foreign objects.</li> <li>5. Remove the Astral from the mobility bag.</li> <li>6. Check the circuit for obstructions.</li> <li>7. Perform a Learn Circuit.</li> </ol>
Disconnection alarm	<ol style="list-style-type: none"> <li>1. Check the patient's status and airway.</li> <li>2. Inspect the circuit and proximal lines for disconnection or excessive leak.</li> <li>3. Perform a Learn Circuit.</li> </ol>
Flow sensor fault	Replace expiratory flow sensor.
Flow sensor not calibrated	Perform a Learn Circuit.

Alarm message	Action
High FiO <sub>2</sub>	<ol style="list-style-type: none"> <li>1. Check the patient's status.</li> <li>2. Check and adjust the oxygen supply.</li> <li>3. Perform a Learn Circuit to recalibrate the oxygen sensor.</li> </ol>
High Leak	<ol style="list-style-type: none"> <li>1. Check the patient's status.</li> <li>2. Inspect the circuit, expiratory valve and proximal lines for leak. When in use, check for leaks around the mask.</li> <li>3. When using vented therapy, check the mask type setting.</li> <li>4. Perform a Learn Circuit.</li> </ol>
High MVe	<ol style="list-style-type: none"> <li>1. Check the patient's status.</li> <li>2. Inspect the expiratory valve. If necessary, replace the expiratory valve.</li> <li>3. Perform a Learn Circuit.</li> </ol>
High MV <sub>i</sub>	<ol style="list-style-type: none"> <li>1. Check the patient's status.</li> <li>2. Inspect the circuit and expiratory module for leaks.</li> <li>3. Perform a Learn Circuit.</li> </ol>
High PEEP	<ol style="list-style-type: none"> <li>1. Check the patient's status.</li> <li>2. Inspect the circuit and expiratory valve for obstruction. When in use, check for obstruction in proximal lines.</li> <li>3. Perform a Learn Circuit.</li> </ol>
High pressure	<ol style="list-style-type: none"> <li>1. Check the patient's status and airway.</li> <li>2. Inspect the circuit for obstruction.</li> <li>3. Perform a Learn Circuit.</li> </ol>
High pressure protection	The hardware pressure safety limit was exceeded. If problem reoccurs, return the device for service.
High Pulse Rate	Check the patient's status.
High Resp Rate	<ol style="list-style-type: none"> <li>1. Check the patient's status.</li> <li>2. Perform a Learn Circuit.</li> </ol>
High SpO <sub>2</sub>	Check the patient's status.
High V <sub>te</sub>	<ol style="list-style-type: none"> <li>1. Check the patient's status.</li> <li>2. Inspect the expiratory valve. If necessary, replace the expiratory valve.</li> <li>3. Perform a Learn Circuit.</li> </ol>
High V <sub>ti</sub>	<ol style="list-style-type: none"> <li>1. Check the patient's status.</li> <li>2. Inspect the circuit and expiratory module for leaks.</li> <li>3. Perform a Learn Circuit.</li> </ol>
Incorrect circuit adapter	<ol style="list-style-type: none"> <li>1. Check that the correct circuit adapter is installed for the selected circuit type.</li> <li>2. Perform a Learn Circuit.</li> </ol>
Incorrect circuit attached	<ol style="list-style-type: none"> <li>1. Check that the circuit is correctly connected and matches the circuit type selected.</li> <li>2. Inspect the circuit, expiratory valve and proximal lines.</li> <li>3. Perform a Learn Circuit.</li> </ol>
Internal battery degraded	<ol style="list-style-type: none"> <li>1. Connect the Astral to mains AC power.</li> <li>2. Return the device for service to replace the internal battery.</li> </ol> <p>The internal battery run time indicator may no longer be accurate and should not be relied upon.</p>
Last self-test failed	<ol style="list-style-type: none"> <li>1. Perform a Learn Circuit.</li> <li>2. If problem persists, return the device for service.</li> </ol>

## Troubleshooting

Alarm message	Action
Low internal battery	Connect the Astral to mains AC power to allow the battery to recharge.
Low FiO <sub>2</sub>	<ol style="list-style-type: none"> <li>1. Check the patient's status.</li> <li>2. Check for leak.</li> <li>3. Check the oxygen supply and connections to the device.</li> <li>4. Perform a Learn Circuit to recalibrate the oxygen sensor.</li> </ol>
Low MVe	<ol style="list-style-type: none"> <li>1. Check the patient's status and airway.</li> <li>2. Inspect the circuit and the expiratory valve for obstruction or leaks.</li> <li>3. Perform a Learn Circuit.</li> </ol>
Low MV <sub>i</sub>	<ol style="list-style-type: none"> <li>1. Check the patient's status and airway.</li> <li>2. Inspect the circuit for obstruction.</li> <li>3. Perform a Learn Circuit.</li> </ol>
Low PEEP	<ol style="list-style-type: none"> <li>1. Check the patient's status.</li> <li>2. Inspect the circuit and the expiratory valve for obstruction or leaks. When in use, check for obstructions in proximal lines.</li> <li>3. Perform Learn Circuit.</li> </ol>
Low pressure	<ol style="list-style-type: none"> <li>1. Check all circuit connections, especially the patient interface and the proximal sense line.</li> <li>2. Inspect the circuit and expiratory valve for damage or secretions.</li> <li>3. Perform a Learn Circuit.</li> </ol>
Low Pulse Rate	Check the patient's status.
Low SpO <sub>2</sub>	Check the patient's status.
Low V <sub>te</sub>	<ol style="list-style-type: none"> <li>1. Check the patient's status and airway.</li> <li>2. Inspect the circuit and the expiratory valve for obstruction or leaks.</li> <li>3. Perform a Learn Circuit.</li> </ol>
Low V <sub>ti</sub>	<ol style="list-style-type: none"> <li>1. Check the patient's status and airway.</li> <li>2. Inspect the circuit for obstruction.</li> <li>3. Perform a Learn Circuit.</li> </ol>
No FiO <sub>2</sub> monitoring	Perform a Learn Circuit to calibrate the oxygen sensor.
No SpO <sub>2</sub> monitoring	<ol style="list-style-type: none"> <li>1. Check the SpO<sub>2</sub> connection to patient's finger and the Astral.</li> <li>2. If the alarm persists, use another SpO<sub>2</sub> oximeter or finger sensor.</li> </ol>
NV Mask/Rebreathing	<p>For vented circuit:</p> <ol style="list-style-type: none"> <li>1. Check that the mask vents are clear and unobstructed.</li> <li>2. Check the mask type setting.</li> <li>3. Perform a Learn Circuit.</li> </ol> <p>For mouthpiece circuit:</p> <p>Check that the interface is a mouthpiece and that the patient is not continuously exhaling into the circuit.</p>
Obstruction	<ol style="list-style-type: none"> <li>1. Check the patient's status and airway.</li> <li>2. Inspect the circuit and the expiratory valve for obstruction. When in use, check for kinks in proximal lines.</li> <li>3. Check the circuit for water.</li> <li>4. Perform a Learn Circuit.</li> </ol>
PEEP blower failure	<ol style="list-style-type: none"> <li>1. Check the patient's status.</li> <li>2. Switch to a back-up ventilator and return the device for service.</li> </ol>

Alarm message	Action
Pressure Line disconnected	<ol style="list-style-type: none"> <li>1. Check the connection of the proximal sense line.</li> <li>2. Check the circuit for water.</li> <li>3. Perform a Learn Circuit.</li> </ol>
Power fault / no charging	<ol style="list-style-type: none"> <li>1. Check all connections between the device and external battery.</li> <li>2. Check connection to mains power (if present). This can be caused by the battery temperature being out of range.</li> </ol> <p>If problem persists, contact your ResMed Service Centre.</p>
Safety reset complete	<p>The device detected a fault and was reset.</p> <ol style="list-style-type: none"> <li>1. Check the patient's status.</li> <li>2. If the alarm persists, switch to a back-up ventilator and return the device for service.</li> </ol>
Safety system fault	<ol style="list-style-type: none"> <li>1. Check the patient's status.</li> <li>2. Transfer the patient to an alternate means of ventilation.</li> <li>3. Return the device for servicing.</li> </ol>
System fault	<ol style="list-style-type: none"> <li>1. Check the patient's status.</li> <li>2. Perform a Learn circuit.</li> <li>3. If problem persists, or the device fails self-test, return the device for service.</li> </ol>
Total power failure	<ol style="list-style-type: none"> <li>1. Check the patient's status and airway.</li> <li>2. Connect the device to AC mains.</li> <li>3. Check the battery charge level of the internal and external (if applicable) battery.</li> </ol> <p>The total power failure alarm can only be silenced by connecting the device to AC mains power.</p>
Using internal battery	<p>Confirm operation on internal battery is intended or restore external power.</p> <p>If intending to use external power:</p> <ol style="list-style-type: none"> <li>1. Check the power cable connection between the mains or battery, the power supply pack and the device.</li> <li>2. If using an external battery, check the external battery charge level and replace/charge if empty.</li> <li>3. If using mains AC, check the supply output.</li> <li>4. If the problem continues, try an alternative external supply type (ie, Mains AC, Mains DC or External Battery).</li> </ol>
Ventilation stopped	<p>Confirm it is appropriate to stop ventilation.</p>

## Learn Circuit troubleshooting

Error code	Action
001	Hardware fault detected. Contact an authorised Service Centre.
104, 105	<p>During the first step of the Learn Circuit, check that the inspiratory port and air inlet filter of the Astral device are clear of obstructions; and the circuit is not connected to the inspiratory port.</p> <p>Repeat Learn Circuit. If the problem persists, contact an authorised Service Centre.</p>
106	Hardware fault detected. Contact an authorised Service Centre.
113	<ol style="list-style-type: none"> <li>1. Check that supplemental oxygen is not added during the Learn Circuit.</li> <li>2. During the first step of the Learn Circuit, check that the inspiratory port and air inlet filter of the Astral device are clear of obstructions; and the circuit is not connected to the inspiratory port.</li> </ol> <p>Repeat Learn Circuit. If the problem persists, contact an authorised Service Centre.</p>
121	<p>Device Test cannot detect the correct circuit adapter.</p> <p><b>Single limb with expiratory valve:</b></p> <ol style="list-style-type: none"> <li>1. Check that the valve control line and proximal pressure line are connected to the single limb adapter correctly. Refer to Connecting a single limb circuit with expiratory valve for further information.</li> <li>2. Check that the single limb circuit adapter is firmly inserted and adapter cover is installed correctly. Refer to Fitting the circuit adapter (see page 23) for further information.</li> </ol> <p><b>Double limb:</b></p> <ol style="list-style-type: none"> <li>1. Check that the double limb circuit adapter is firmly inserted and adapter cover is installed correctly. Refer to Fitting the circuit adapter (see page 23) for further information.</li> </ol> <p><b>Single limb with intentional leak:</b></p> <ol style="list-style-type: none"> <li>1. Check the single limb leak adapter is firmly inserted and adapter cover is installed correctly. Refer to Fitting the circuit adapter (see page 23) for further information.</li> </ol> <p>Repeat Learn Circuit. If the problem persists, contact an authorised Service Centre.</p>
122	Hardware fault detected. Contact an authorised Service Centre.
123	<p>Air Inlet Filter is not detected.</p> <p>Check that the air inlet filter is clean, dry and correctly installed. Replace if necessary. Refer to Replacing the air filter.</p> <p>Repeat Learn Circuit. If the problem persists, contact an authorised Service Centre.</p>
124	Ensure that all filters and circuits are disconnected from the inspiratory port. Repeat Learn Circuit. If the problem persists, contact an authorised Service Centre.
125	Hardware fault detected. Contact an authorised Service Centre.



Error code	Action
204	<p>Unable to learn the circuit.</p> <ol style="list-style-type: none"> <li>1. Ensure that the circuit is not moved until completion of the test.</li> <li>2. Check the circuit and attached accessories for blockages.</li> <li>3. Ensure that there are no sharp bends or kinks in the circuit and the patient end is not blocked.</li> <li>4. If using humidification, ensure that the humidifier tub is not overfilled.</li> <li>5. Follow the on-screen instructions carefully: <ul style="list-style-type: none"> <li>• circuit should not be blocked during step 2</li> <li>• circuit should be completely blocked during step 3.</li> </ul> </li> </ol> <p>If the problem persists, contact your clinician or an authorised Service Centre.</p>
205	<p>The measured circuit resistance exceeds safe operating limits for this device.</p> <ol style="list-style-type: none"> <li>1. Check the circuit and attached accessories for blockages.</li> <li>2. Ensure that there are no sharp bends or kinks in the circuit and the patient end is not blocked.</li> <li>3. If using humidification, ensure that the humidifier tub is not overfilled.</li> <li>4. Follow the on-screen instructions carefully: <ul style="list-style-type: none"> <li>• circuit should not be blocked during step 2</li> <li>• circuit should be completely blocked during step 3.</li> </ul> </li> </ol> <p>If the problem persists, contact your clinician or an authorised Service Centre.</p>
206	<p>Hardware fault detected. Contact an authorised Service Centre.</p>
303	<p>Unable to calibrate oxygen sensor.</p> <ol style="list-style-type: none"> <li>1. Check that supplemental oxygen is not added during the Learn Circuit.</li> <li>2. Repeat Learn Circuit.</li> </ol> <p>If the problem persists, contact an authorised Service Centre.</p>
404, 405, 406	<p>Hardware fault detected. Contact an authorised Service Centre.</p>
409	<p>Learn Circuit was unable to complete due to excessive leak from the circuit.</p> <ol style="list-style-type: none"> <li>1. Check that the circuit is completely blocked during the third step of the Learn Circuit.</li> <li>2. Check that the circuit is assembled correctly and there are no leaks in the circuit.</li> <li>3. Check that the circuit adapter is firmly inserted.</li> <li>4. This circuit may not be compatible with the Astral device. Try another circuit.</li> </ol> <p>Repeat Learn Circuit. If the problem persists, contact an authorised Service Centre.</p>
415	<p>Hardware fault detected. Contact an authorised Service Centre.</p>
420	<p>The measured circuit compliance exceeds safe operating limits for this device.</p> <p>Check that the circuit is assembled correctly and completely blocked during the third step of the Learn Circuit.</p> <p>If the problem persists, contact your clinician or an authorised Service Centre.</p>
426	<p>Hardware fault detected. Contact an authorised Service Centre.</p>

## Troubleshooting

Error code	Action
504	<p>Unable to learn the circuit.</p> <ol style="list-style-type: none"><li>1. Ensure that the circuit is not moved until completion of the test.</li><li>2. Check the circuit and attached accessories for blockages.</li><li>3. Ensure that there are no sharp bends or kinks in the circuit and the patient end is not blocked.</li><li>4. If using humidification, ensure that the humidifier tub is not overfilled.</li><li>5. Follow the on-screen instructions carefully:<ul style="list-style-type: none"><li>• circuit should not be blocked during step 2</li><li>• circuit should be completely blocked during step 3.</li></ul></li></ol> <p>If the problem persists, contact your clinician or an authorised Service Centre.</p>
505	<p>The measured circuit resistance exceeds safe operating limits for this device.</p> <ol style="list-style-type: none"><li>1. Check the circuit and attached accessories for blockages.</li><li>2. Ensure that there are no sharp bends or kinks in the circuit and the patient end is not blocked.</li><li>3. If using humidification, ensure that the humidifier tub is not overfilled.</li><li>4. Follow the on-screen instructions carefully:<ul style="list-style-type: none"><li>• circuit should not be blocked during step 2</li><li>• circuit should be completely blocked during step 3.</li></ul></li></ol> <p>If the problem persists, contact your clinician or an authorised Service Centre.</p>
506, 512	<p>Hardware fault detected. Contact an authorised Service Centre.</p>
600	<p>Unable to calibrate Expiratory Flow Sensor.</p> <ol style="list-style-type: none"><li>1. Check the circuit adapter is clean, dry and firmly inserted.<ul style="list-style-type: none"><li>• If the adapter is wet, then removing the adapter and vigorously shaking to clear water can be effective. Re-insert adapter firmly and repeat Learn Circuit.</li><li>• If the adapter is not clean, then it will need to be replaced.</li></ul></li><li>2. If using a small diameter pediatric breathing circuit, consider using an anti-bacterial filter or a 22-mm adapter on the expiratory adapter port.</li><li>3. Repeat Learn Circuit and ensure that the circuit is not moved until completion of the test.</li></ol> <p>If the problem persists, contact an authorised Service Centre.</p>

## General troubleshooting

Issue	Action
Condensation forming in circuit	Condensation may form due to high humidity settings and low ambient temperatures. Adjust humidifier settings in accordance with manufacturer's instructions.
Touch screen damaged or non-responsive	<p>If you are unable to power off the Astral device normally, use the following forced shutdown procedure:</p> <ol style="list-style-type: none"> <li>1. Disconnect any external power source (eg, AC mains or external battery).</li> <li>2. Press and hold the green on/off button and the alarm mute/reset button for at least 10 seconds. After 10 seconds the alarm bar will flash yellow.</li> <li>3. Release both buttons. Astral will then power off.</li> <li>4. The Astral device can be powered back on by pressing the on/off button and used as intended.</li> </ol>
Unable to save data from Astral to USB or USB is not detected by device.	<ol style="list-style-type: none"> <li>1. Remove and reinsert the USB stick.</li> <li>2. Use a new USB stick.</li> <li>3. Remove the AC or external DC power supply, the restart the Astral by switching it off then on.</li> <li>4. Reformat your USB stick. Note that any data currently saved on the USB will be lost.</li> </ol>
Learn Circuit failed	<p>If the Learn Circuit fails and a warning message appears on the top of the Learn Circuit results page, try the following:</p> <ol style="list-style-type: none"> <li>1. Check the circuit for Leak.</li> <li>2. Check the module, the blue membrane and sensor are pressed all the way in and sit flush with the enclosure.</li> <li>3. Hold the circuit straight to reduce resistance.</li> </ol> <p>Note: It is acceptable to use a circuit that gives a caution message as the Astral device will compensate for circuit resistance and compliance.</p>
Flow Sensor failed (Astral 150 only)	<p>If the Flow Sensor fails and a message appears on the bottom of the Learn Circuit results page, try the following:</p> <ol style="list-style-type: none"> <li>1. Check the circuit for Leak.</li> <li>2. Check the expiratory valve, the blue membrane and sensor are pressed all the way in and sit flush with the enclosure.</li> </ol>

## Technical specifications

Operating pressure range	<p>Single limb with valve or double limb with valve: 3 to 50 hPa</p> <p>Single limb with intentional leak: 2 to 50 hPa</p> <p>CPAP: 3 to 20 hPa</p> <p>Maximum working pressure limit: 10 to 80* hPa</p> <p>*Not applicable on all device variants</p> <p>Forced cycling occurs if the Pressure alarm limit is exceeded.</p>
Operating tidal volume range (volume control modes)	<p>Adult patient type: 100 to 2500 mL</p> <p>Pediatric patient type: 50 to 300 mL*</p>
Circuit resistance and compliance range for stated accuracy of monitoring and control**	<p>Pediatric patient setting:</p> <p>Circuit resistance range (circuit with intentional leak): 0 to 8 hPa at 60 L/min</p> <p>Circuit resistance range (circuit with valve): 0 to 20 hPa at 60 L/min</p> <p>Circuit resistance range (mouthpiece circuit): 0 to 5 hPa at 60 L/min</p> <p>Circuit compliance range: 0 to 4 mL / hPa</p> <hr/> <p>Adult patient setting:</p> <p>Circuit resistance range (circuit with intentional leak): 0 to 20 hPa at 120 L/min</p> <p>Circuit resistance range (circuit with valve): 0 to 35 hPa at 120 L/min</p> <p>Circuit resistance range (mouthpiece circuit): 0 to 15 hPa at 120 L/min</p> <p>Circuit compliance range: 0 to 4 mL / hPa</p>
Breathing resistance under single fault***	<p>Pediatric circuit</p> <p>Inspiration: 2.2 hPa (at 15 L/min), 5.3 hPa (at 30 L/min)</p> <p>Expiration: 2.4 hPa (at 15 L/min), 5.0 hPa (at 30 L/min)</p> <p>Adult circuit</p> <p>Inspiration: 5.7 hPa (at 30 L/min), 8.3 hPa (at 60 L/min)</p> <p>Expiration: 4.2 hPa (at 30 L/min), 6.2 hPa (at 60 L/min)</p>
Maximum flow	220 L/min
Inspiratory trigger (nominal) characteristics	<p>Inspiratory trigger occurs when patient flow exceeds trigger setting.</p> <p>Double limb with valve (flow trigger): 0.5 to 15.0 L/min</p> <p>Single limb with valve or double limb with valve: 1.6 to 10.0 L/min (in five steps)****</p> <p>Single limb with intentional leak: 2.5 to 15.0 L/min (in five steps)</p> <p>Mouthpiece (tube only) circuit: 2.0 to 4.0 L/min (in four steps)</p>
Expiratory cycle (nominal) characteristics	<p>Cycle occurs when inspiratory flow declines to the set percentage of peak inspiratory flow.</p> <p>5 to 90%</p>
Sound pressure level	35 ± 3 dBA as measured according to ISO 80601-2-72:2015
Sound power level	43 ± 3 dBA as measured according to ISO 80601-2-72:2015
Alarm volume range	56–85 dBA (in five steps) as measured according to IEC60601-1-8:2012
Data storage	<p>7 days of high-resolution airway pressure, respiratory flow and delivered volume (sampled at 25 Hz).</p> <p>7 days of breath-related therapy data (sampled at 1 Hz).</p> <p>365 days of statistical data per program.</p>

Dimensions (L x W x H)	285 mm x 215 mm x 93 mm (11.22" x 8.47" x 3.66") Display screen size: 150 mm x 90 mm (5.91" x 3.54")
Weight	3.2 kg (7.1 lb)
Inspiratory port / double limb adapter	22 mm taper, compatible with ISO 5356-1:2004 Anesthetic & Respiratory Equipment – Conical Connectors
Pressure measurement	Internally mounted pressure transducers
Flow measurement	Internally mounted flow transducers
Power supply	AC 100–240V, 50–60Hz, 90 W 3.75 A continuous, 120 W / 5A peak 110V/400 Hz
External DC Power Supply	12 - 24V DC 90 W, 7.5 A / 3.75 A
Internal Battery	Lithium-Ion battery, 14.4 V, 6.6 Ah, 95 Wh Operating hours (standard case): 8 hours with a new battery under normal conditions Test conditions: Adult, (A)CV mode, Vt = 800 mL, PEEP = 5 cmH <sub>2</sub> O, Rate = 20 bpm, Ti = 1.0 sec. All other parameters remain at default settings. Operating hours (worst case) > 4 hour run time under the following conditions: Test conditions: Adult, non-vented, PACV mode, Double limb circuit, Pressure Assist = 30 cmH <sub>2</sub> O, PEEP = 20 cmH <sub>2</sub> O Rate:20 bpm, Ti: 1.0 sec, Rise Time = Min, Safety Vt = Off, Trig = Off. All other parameters remain at default settings. Total lifetime: up to 3,000 hours of normal operation on internal battery Note: Time may vary with different settings and environmental conditions.
Housing construction	Flame retardant engineering thermoplastic
Environmental conditions	Operating temperature: 32°F to 104°F (0°C to 40°C) Charging temperature: 41°F to 95°F (5°C to 35°C) Operating humidity: 5 to 93% non-condensing Storage and transport temperature: -4°F to 122°F (-20°C to 50°C) for up to 24 hours Storage and transport temperature: -13°F to 158°F (-25°C to 70°C) for greater than 24 hours <b>Note:</b> Storing the Astral device at temperatures exceeding 122°F (50°C) for extended period of time may accelerate battery aging. This will not affect the safety of the battery or device. Refer to Using the internal battery (see page 45) Storage and transport humidity: 5 to 93% non-condensing It takes 40 minutes* for the device to be ready for use on a patient when removed from storage at the minimum long term temperature and at an ambient temperature of 68°F (20°C). *Assumes that the device is connected to an external AC power. It takes 60 minutes for the device to be ready for use on a patient when removed from storage at the maximum long term temperature and at an ambient temperature of 68°F (20°C). Air pressure: 1100 hPa to 700 hPa Altitude: 9842 ft (3000 m) <b>Note:</b> The performance may be limited below 800 hPa or at altitudes above 6562 ft (2000 m).

## Technical specifications

	<p>IP22 (Protected against finger sized objects. Protected against dripping water when tilted up to 15 degrees from specified orientation.) When placed horizontally on flat surface, or vertically with handle up.</p> <p>IP21 (Protected against finger sized objects and against vertically dripping water) when placed on a table stand, when used with the ResMed Homecare Stand or when attached to the RCM or RCMH.</p>
Oxygen measurement	<p>Internally mounted oxygen sensor.</p> <p>1,000,000 % hours at 25°C</p>
Electromagnetic compatibility	<p>Product complies with all applicable electromagnetic compatibility requirements (EMC) according to IEC60601-1-2 for Medical Equipment in the home and professional healthcare environments; and emergency medical service environment.</p> <p>It is recommended that mobile communication devices are kept at least one metre away from the device.</p> <p>For further details see "<b>Guidance and manufacturer's declaration – electromagnetic emissions and immunity</b>" (see page 77).</p>
Aircraft use	<p>Medical-Portable Electronic Devices (M-PED) that meet the Federal Aviation Administration (FAA) requirements of RTCA/DO-160 can be used during all phases of air travel without further testing or approval by the airline operator.</p> <p>ResMed confirms that the Astral meets the Federal Aviation Administration (FAA) requirements (RTCA/DO-160, section 21, category M) for all phases of air travel.</p> <p>IATA classification for internal battery: UN 3481 – Lithium-Ion batteries contained in equipment.</p>
Automotive use	<p>Product complies with ISO 16750-2 Road Vehicles - Environmental Conditions and Testing for Electrical and Electronic Equipment - Part 2: Electrical Loads" - 2nd Edition 2006, Tests 4.2, 4.3.1.2, 4.3.2, 4.4, 4.6.1 and 4.6.2. The functional status classification shall be Class A.</p> <p>Product complies with ISO7637-2 "Road Vehicles - Electrical Disturbance by Conduction and Coupling - Part 2 Electrical Transient Conduction Along Supply Lines Only" - 2nd Edition 2004, Section 4.4 Transient Immunity Test. The functional status classification shall be Class A to test level III and Class C to test level IV.</p>
Data connections	<p>The Astral device has three data connection ports (USB connector, mini USB connector, and Ethernet port). Only the USB and mini-USB connectors are for customer use.</p> <p>The USB connector is compatible with the ResMed USB stick.</p>
Recommended patient circuit components and compatible accessories	<p>Refer to <a href="http://www.resmed.com/astral/circuits">www.resmed.com/astral/circuits</a>.</p>
IEC 60601-1 classifications	<p>Class II (double insulation)</p> <p>Type BF</p> <p>Continuous operation</p> <p>Suitable for use with oxygen.</p>
Applied parts	<p>Patient interface (Mask, endotracheal tube, tracheostomy tube or mouthpiece).</p> <p>Oximeter.</p>

Intended operator	The patient, carer or clinician is an intended operator of the Astral device. Some functions and settings can only be adjusted by the clinician (in Clinical Mode). These functions are disabled / locked from use in Patient mode.
Operator position	The device is designed to be operated within arm's length. An operator should position their line of sight within an angle of 30 degrees from a plane perpendicular to the screen. The Astral device complies with IEC60601-1:2005 legibility requirements.
Software release compatibility	For information on your device software version, contact your ResMed representative.

This device is not suitable for use in the presence of a flammable anesthetic mixture.

\*The International ventilator standard indicates that Pediatric patient type is intended to be used for a patient receiving less than 300 mL, however Astral permits adjustment of 'Vt' setting parameter up to 500 mL for cases where 'Vt' is set such that it compensates for leak in the breathing circuit.

 **WARNING**

**ResMed does not recommend 500 mL as the upper limit for the pediatric tidal volume use; however, clinicians may choose this upper limit based on their clinical determination.**

\*\* To achieve specified accuracies, a successful Learn Circuit must be performed.

\*\*\* Limits are the sum of device and circuit impedance under single fault leading to device shutdown.

\*\*\*\* Individual configurations may be more sensitive.

The life of oxygen cells is described by hours used multiplied by the % of oxygen used. For example 1 000 000 % hours oxygen cell will last for 20 000 hours at 50% FiO<sub>2</sub> (20 000 x 50 = 1 000 000) or 40 000 hours at 25% FiO<sub>2</sub> (40 000 x 25 = 1 000 000). Astral's oxygen cell will last for 25,000 hours (1041 days) at 40% FiO<sub>2</sub>

## Technical specifications

### Pneumatic flow path

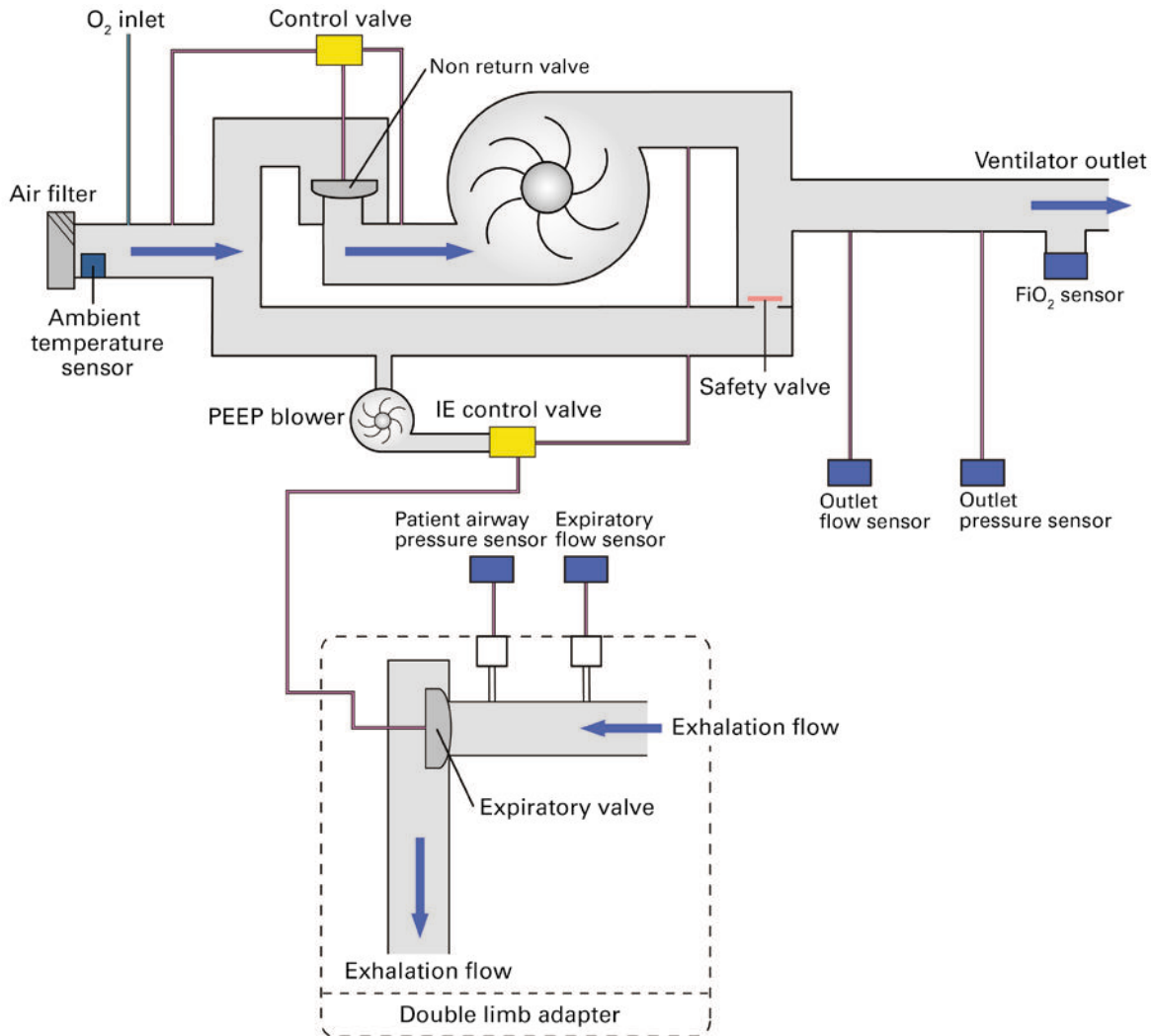

### WARNING

Under normal or single fault conditions the entire pneumatic flow path can become contaminated with body fluids or expired gases if antibacterial filters are not installed on the ventilator outlet and double limb adapter exhalation port.



## Guidance and Manufacturer’s Declaration Electromagnetic Emissions & Immunity

Medical electrical equipment needs special precautions regarding EMC and needs to be installed and put into service according to EMC information provided in this document.

This declaration currently applies for the following ResMed devices:

- Astral™ Series of Ventilators.

### Guidance and manufacturer’s declaration—electromagnetic emissions

These devices are intended for use in the electromagnetic environment specified below. The customer or the user of the device should assure that the device is used in such an environment.

Emissions test	Compliance	Electromagnetic environment—guidance
RF emissions CISPR 11	Group 1	The device uses RF energy only for its internal function. Therefore, its RF emissions are very low and are not likely to cause any interference in nearby electronic equipment.
RF emissions CISPR 11 with or without USB adapter with or without Oximeter adapter	Class B	The device is suitable for use in all establishments, including domestic establishments and those directly connected to the public low-voltage network that supplies buildings used for domestic purposes.
Harmonic Emissions IEC 61000-3-2 with or without specified accessories	Class A	
Voltage Fluctuations/Flicker Emissions IEC 61000-3-3 with or without specified accessories	Complies	

### WARNING

- The device should not be used adjacent to or stacked with other equipment. If adjacent or stacked use is necessary, the device should be observed to verify normal operation in the configuration in which it will be used.
- The use of accessories other than those specified for the device is not recommended. They may result in increased emissions or decreased immunity of the device.
- Additional equipment connected to medical electrical equipment must comply with the respective IEC or ISO standards (eg, IEC 60950 for data processing equipment). Furthermore all configurations shall comply with the requirements for medical electrical systems (see IEC 60601-1-1 or clause 16 of the 3Ed. of IEC 60601-1, respectively). Anybody connecting additional equipment to medical electrical equipment configures a medical system and is therefore responsible that the system complies with the requirements for medical electrical systems. Attention is drawn to the fact that local laws take priority over the above mentioned requirements. If in doubt, consult your local representative or the technical service department.
- Portable RF communications equipment (including peripherals such as antenna cables and external antennas) should be used no closer than 30 cm to any part of the device, including cables specified by the manufacturer. Otherwise, degradation of the performance of this equipment could result.

## Technical specifications

### Guidance and manufacturer's declaration – electromagnetic immunity

These devices are intended for use in the electromagnetic environment specified below. The customer or the user of the device should assure that the device is used in such an environment.

Immunity test	IEC60601-1-2 test level, Ed. 4	Compliance level	Electromagnetic environment—guidance
Electrostatic discharge (ESD) IEC 61000-4-2	±8 kV contact ±15 kV air	±8 kV contact ±15 kV air	Floors should be wood, concrete or ceramic tile. If floors are covered with synthetic material, the relative humidity should be at least 30%.
Electrical fast transient/burst IEC 61000-4-4	±2 kV for power supply lines ±1 kV for input/output lines	±2 kV for power supply lines ±1 kV for input/output lines	Mains power quality should be that of a typical commercial or hospital environment.
Surge IEC 61000-4-5	±1 kV differential mode ±2 kV common mode	±1 kV differential mode ±2 kV common mode	Mains power quality should be that of a typical commercial or hospital environment.
Voltage dips, short interruptions and voltage variations on power supply input lines IEC 61000-4-11	<5% $U_t$ (>95% dip in $U_t$ ) for 0.5 cycle 40% $U_t$ (60% dip in $U_t$ ) for 5 cycles 70% $U_t$ (30% dip in $U_t$ ) for 25 cycles <5% $U_t$ (>95% dip in $U_t$ ) for 5 sec	<12V (>95% dip in 240V) for 0.5 cycle 96V (60% dip in 240V) for 5 cycles 168V (30% dip in 240V) for 25 cycles <12V (>95% dip in 240V) for 5 sec	Mains power quality should be that of a typical commercial or hospital environment. If the user of the device requires continued operation during power mains interruptions, it is recommended that the device be powered from an uninterruptible power source. The internal battery will provide backup power of eight hours.
Power frequency (50/60 Hz) magnetic field IEC 61000-4-8	30 A/m	30 A/m	Power frequency magnetic fields should be at levels characteristic of a typical location in a typical commercial or hospital environment.
Conducted RF for life support IEC 61000-4-6	3 Vrms outside ISM bands 10 Vrms inside ISM bands	10 Vrms 150 kHz to 80 MHz	Portable and mobile RF communications equipment should be used no closer to any part of the device, including cables, than the recommended separation distance calculated from the equation applicable to the frequency of the transmitter. See separation distance table below. $d = 0.35 \sqrt{P}$ outside ISM bands $d = 1.2 \sqrt{P}$ inside ISM bands

Immunity test	IEC60601-1-2 test level, Ed. 4	Compliance level	Electromagnetic environment—guidance
Radiated RF IEC 61000-4-3	10 V/m 80 MHz to 2.5 GHz for Home environment	10 V/m 80 MHz to 2.5 GHz	<p><b>Recommended separation distance for life support equipment</b></p> <p><math>d = 1.2 \sqrt{P}</math> 80 MHz to 800 MHz  <math>d = 2.3 \sqrt{P}</math> 800 MHz to 2.5 GHz</p> <p>Where (P) is the maximum output power rating of the transmitter in watts (W) according to the transmitter manufacturer and d is the recommended separation distance in meters (m). Field strengths from fixed RF transmitters, as determined by an electromagnetic site survey,<sup>a</sup> should be less than the compliance level in each frequency range.<sup>b</sup> Interference may occur in the vicinity of equipment marked with the following symbol: </p>

<sup>a</sup>Field strengths from fixed transmitters, such as base stations for radio (cellular/cordless) telephones and land mobile radios, amateur radio, AM and FM radio broadcast and TV broadcast cannot be predicted theoretically with accuracy. To assess the electromagnetic environment due to fixed RF transmitters, an electromagnetic site survey should be considered. If the measured field strength in the location in which the device is used exceeds the applicable RF compliance level above, the device should be observed to verify normal operation. If abnormal performance is observed, additional measures may be necessary, such as reorienting or relocating the device.

<sup>b</sup>Over the frequency range 150 kHz to 80 MHz, field strengths should be less than 10 V/m.

Notes:

- Ut is the AC mains voltage prior to application of the test level.
- At 80 MHz and 800 MHz, the higher frequency range applies.
- These guidelines may not apply in all situations. Electromagnetic propagation is affected by absorption and reflection from structures, objects and people.
- ISM bands: 6.765 to 6.795MHz, 13.533 to 13.567MHz, 26.957 to 27.283MHz and 40.66 to 40.70Mz

## Technical specifications

### Recommended separation distances between portable and mobile RF communications equipment and the life support device

These devices are intended for use in an environment in which radiated RF disturbances are controlled. The customer or the user of the device can help prevent electromagnetic interference by maintaining a minimum distance between portable and mobile RF communications equipment (transmitters) and the device as recommended below, according to the maximum output power of the communications equipment.

Rated maximum output power of transmitter (W)	Separation distance according to frequency of transmitter (m)			
	150 kHz to 80 MHz Outside ISM bands $d = 0.35 \sqrt{P}$	150 kHz to 80 MHz Inside ISM bands $d = 1.2 \sqrt{P}$	80 MHz to 800 MHz $d = 1.2 \sqrt{P}$	800MHz to 2.5 GHz $d = 2.3 \sqrt{P}$
0.01	0.1	0.1	0.1	0.2
0.1	0.1	0.4	0.4	0.7
1	0.4	1.2	1.2	2.3
10	1.1	3.8	3.8	7.3
100	3.5	12.0	12.0	23.0

For transmitters rated at a maximum output power not listed above, the recommended separation distance  $d$  in metres (m) can be determined using the equation applicable to the frequency of the transmitter, where  $P$  is the maximum output power rating of the transmitter in watts (W) according to the transmitter manufacturer.

Notes:

- At 80 MHz and 800 MHz, the separation distance for the higher frequency range applies.
- These guidelines may not apply in all situations. Electromagnetic propagation is affected by absorption and reflection from structures, objects and people.

### Potential impact of electromagnetic disturbances

The loss or degradation of the following clinical functions due to electromagnetic disturbances could result in compromised patient safety:

- Accuracy of ventilation control
- Accuracy of monitoring of airway pressure, expired volume and  $FiO_2$
- Therapy alarms.

Detection of this degradation could be observed by the following device behaviour:

- Erratic ventilation delivery
- Rapid fluctuations in monitored parameters
- False activation of therapy or technical alarms (eg, System Fault or Battery comms lost alarms)

# Symbols

The following symbols may appear on your product or packaging.

 Indicates a Warning or Caution

 Follow instructions for use

 Batch code

 Catalogue number

 Serial number

 Humidity Limitation

 Temperature Limitation

 Keep upright

 Keep dry

 Fragile, handle with care

 Recyclable

 Fire if damaged

 Manufacturer

 European Authorised Representative

 CE Labelling in accordance with EC directive 93/42/EEC

 Canadian Standards Association

**Rx Only** Prescription only (In the US, Federal law restricts these devices to sale by or on the order of a physician.)

 Device weight

**IP22** Protected against finger sized objects. Protected against dripping water when tilted up to 15 degrees from specified orientation.

 **Environmental information**

This device should be disposed of separately, not as unsorted municipal waste. To dispose of your device, you should use appropriate collection, reuse and recycling systems available in your region. The use of these collection, reuse and recycling systems is designed to reduce pressure on natural resources and prevent hazardous substances from damaging the environment.

If you need information on these disposal systems, please contact your local waste administration. The crossed-bin symbol invites you to use these disposal systems. If you require information on collection and disposal of your ResMed device please contact your ResMed office, local distributor or go to [ResMed.com/environment](http://ResMed.com/environment).

**Li-Ion** Lithium Ion battery

 Type BF applied part

 Class II equipment

 On/Off

 Power plug

**SpO2** Oximeter connector

 Ventilation indicator

 Alternating current

 Direct current

 Battery

 Alarm Mute / Reset (Audio Pause)

 Oxygen supply inlet connector

 Connector for control line of external expiratory valve

 Connector for the breathing pressure measuring line

 Expiratory Connector (From Patient)

 Inspiratory Connector (To Patient)

 USB connector

 Ethernet connector

 Remote Alarm connector

 Remote Alarm Test button

 MR unsafe (do not use in the vicinity of an MRI device).

## Standards compliance

The Astral meets the following standards:

- IEC 60601-1 Medical Electrical Equipment - General Requirements for Basic Safety and Essential Performance
- IEC 60601-1-2 Medical electrical equipment - Part 1-2: General requirements for basic safety and essential performance - Collateral standard: Electromagnetic compatibility -Requirements and tests
- IEC 60601-1-8 General requirements, test and guidance for alarm systems in medical electrical equipment and medical electrical systems
- IEC 60601-1-11 Medical electrical equipment - Part 1-11: General requirements for basic safety and essential performance - Collateral standard: Requirements for medical electrical equipment and medical electrical systems used in the home healthcare environment
- ISO 80601-2-72 Medical electrical equipment - Part 2-72: Particular requirements for basic safety and essential performance of home healthcare environment ventilators for ventilator-dependent patients

## Training and support

For training and support materials, please contact your ResMed representative.

## Limited warranty

ResMed Pty Ltd (hereafter 'ResMed') warrants that your ResMed product shall be free from defects in material and workmanship from the date of purchase for the period specified below.

Product	Warranty period
<ul style="list-style-type: none"> <li>• Mask systems (including mask frame, cushion, headgear and tubing)—excluding single-use devices</li> <li>• Accessories—excluding single-use devices</li> <li>• Flex-type finger pulse sensors</li> <li>• Humidifier water tubs</li> </ul>	90 days
<ul style="list-style-type: none"> <li>• Batteries for use in ResMed internal and external battery systems</li> </ul>	6 months
<ul style="list-style-type: none"> <li>• Clip-type finger pulse sensors</li> <li>• CPAP and bilevel device data modules</li> <li>• Oximeters and CPAP and bilevel device oximeter adapters</li> <li>• Humidifiers and humidifier cleanable water tubs</li> <li>• Titration control devices</li> </ul>	1 year
<ul style="list-style-type: none"> <li>• CPAP, bilevel and ventilation devices (including external power supply units)</li> <li>• Battery accessories</li> <li>• Portable diagnostic/screening devices</li> </ul>	2 years

This warranty is only available to the initial consumer. It is not transferable.

If the product fails under conditions of normal use, ResMed will repair or replace, at its option, the defective product or any of its components.

This Limited Warranty does not cover: a) any damage caused as a result of improper use, abuse, modification or alteration of the product; b) repairs carried out by any service organization that has not been expressly authorized by ResMed to perform such repairs; c) any damage or contamination due to cigarette, pipe, cigar or other smoke; and d) any damage caused by water being spilled on or into an electronic device.

Warranty is void on product sold, or resold, outside the region of original purchase.

Warranty claims on defective product must be made by the initial consumer at the point of purchase.

This warranty replaces all other expressed or implied warranties, including any implied warranty of merchantability or fitness for a particular purpose. Some regions or states do not allow limitations on how long an implied warranty lasts, so the above limitation may not apply to you. ResMed shall not be responsible for any incidental or consequential damages claimed to have resulted from the sale, installation or use of any ResMed product. Some regions or states do not allow the exclusion or limitation of incidental or consequential damages, so the above limitation may not apply to you.

This warranty gives you specific legal rights, and you may also have other rights which vary from region to region. For further information on your warranty rights, contact your local ResMed dealer or ResMed office.

## Appendix A: Definitions

### Ventilation settings definitions

The available settings will vary with the selection of the ventilation mode. Each mode details the settings available.

Setting	Definition
Apnea Definition	Apnea Definition sets the type of breath which must be delayed for an apnea to be detected.
Apnea Interval (T apnea)	Apnea Interval (T apnea) sets the period without breath or spontaneous breath required for an apnea to be detected.
Apnea Response	Apnea Response sets the behaviour of the ventilator when an apnea is detected.
Circuit Type	Circuit Type sets whether a Double limb circuit, Single limb circuit with expiratory valve or Single limb circuit with intentional leak is in use.
CPAP	Continuous Positive Airway Pressure (CPAP) sets the pressure maintained throughout a spontaneous breath.
Cycle	Cycle (also known as Expiratory Trigger) sets the threshold where start of expiration within a breath is detected.
EPAP	Expiratory Positive Airway Pressure (EPAP) sets the pressure to be delivered to the patient during expiration.
Flow shape	Sets the target flow waveform for the delivery of mandatory controlled volume breaths.
Inspiratory duration option (Insp Duration Option)	Inspiratory duration option (Insp Duration Option) sets whether Inspiration Time (Ti) or Peak Inspiratory Flow (PIF) is used to configure volume controlled breaths.
Interface type	Invasive, mask, or mouthpiece
Interval	Sigh interval sets the period between sigh breaths.
IPAP	Inspiratory Positive Airway Pressure (IPAP) sets the pressure to be delivered to the patient during inspiration.
Magnitude	Magnitude sets the size of the manual or sigh breath delivered relative to the size of the normal ventilation breath. Separate magnitude settings are available for configuration of manual or sigh breaths.
Manual Breath	Manual Breath sets whether a manual breath is available for delivery.
Mask Type	Mask Type sets the type of mask or in-line vent in use when the circuit type is single with leak.
Max EPAP	Maximum Expiratory Positive Airway Pressure (Max EPAP) sets the maximum pressure to be delivered to the patient during expiration to maintain upper airway patency.
Max PS	Maximum Pressure Support (Max PS) sets the maximum pressure support above EPAP allowed to achieve the Target Va.
Min EPAP	Minimum Expiratory Positive Pressure (Min EPAP) sets the minimum pressure allowed to be delivered to the patient during expiration to maintain upper airway patency.  The Min EPAP should be set to treat any lower airway condition.
Min PS	Minimum Pressure Support (Min PS) sets the minimum pressure support above EPAP allowed to achieve the Target Va (iVAPS).
P control	Pressure control (P control) sets the pressure support above PEEP to be delivered during inspiration for pressure assisted breaths.



Setting	Definition
P control max	Maximum allowed pressure control (P control max) sets the maximum pressure control above PEEP allowed to achieve the target safety volume.
Patient type	Select from Adult or Pediatric. This setting configures the default values and ranges available for ventilation settings and determines circuit resistance acceptance criteria applied in the Learn Circuit.
PEEP	Positive End Expiratory Pressure (PEEP) sets the pressure maintained during exhalation.
PIF	Peak Inspiratory Flow (PIF) sets the maximum delivered flow for volume controlled breaths.
PS	Sets the pressure support above PEEP to be delivered during inspiration for pressure supported breaths (spontaneous breaths).
PS Max	Maximum allowed Pressure Support (PS Max) sets the maximum pressure support above PEEP allowed to achieve the target safety tidal volume.
Pt Height	Patient Height (Pt Height) is used to estimate the patient's anatomical deadspace and Ideal Body Weight (IBW).
Resp. rate	Respiratory rate (Resp. rate) sets the breaths per minute (bpm) to be delivered by the ventilator to the patient. The measured respiratory rate may be greater due to patient triggered breaths.
Rise Time	Rise time sets the time taken for the ventilator to reach inspiratory pressure for pressure controlled breaths.
Safety Vt	Safety tidal volume sets the target minimum tidal volume (Vt) for each ventilator delivered breath.
Sigh Alert	Sigh alert sets whether the ventilator gives a single beep just prior to delivery of a sigh breath.
Sigh Breath	Sigh Breath sets whether a magnified breath (a sigh breath) will be delivered at the sigh interval.
Target Pt Rate	Target Patient Rate (Target Pt Rate) sets the upper boundary for the iVAPS intelligent Backup Rate (iBR).
Target Va	Target Alveolar Minute Ventilation (Target Va) sets the servo-ventilation target for iVAPS.
Ti	Inspiration time (Ti) sets the duration of the inspiratory phase of a breath.
Ti Max	Maximum inspiratory time (Ti Max) sets the maximum duration of the inspiratory phase of a breath.
Ti Min	Minimum Inspiratory Time (Ti Min) set the minimum duration of the inspiratory phase of a breath.
Trigger	Sets the trigger threshold above which the ventilator triggers a new breath. The trigger is blocked for the first 300 ms following the start of exhalation.
Trigger type	Trigger type sets whether a pressure based trigger threshold or flow based trigger threshold is used when a Double circuit is selected.
Vt	The Tidal Volume (Vt) sets the volume of gas, measured in mL, to be delivered to the patient in a mandatory controlled volume breath.

## Measured and calculated parameter definitions

The following measured and calculated parameters are displayed during configuration or during ventilation. Each Ventilation mode details the parameters displayed.

Parameter	Definition
FiO <sub>2</sub>	Average of percentage of Oxygen delivered to circuit.
I:E	I:E is the ratio of the inspiratory period to the expiratory period. The measured I:E ratio is displayed as a monitored parameter during ventilation. The expected I:E ratio is calculated and displayed on the settings screens if the Resp. rate setting is not set to Off.
Leak	Leak is the average unintentional leak. It is reported as a percentage for Double limb circuits and as a flow for Single limb circuits with intentional leak. The measured Leak is displayed as a monitored parameter during ventilation.
MV	Minute Ventilation (MV) is the product of the Target Patient Rate (Target Pt Rate) and expired tidal volume averaged over the last eight breaths. The MV is displayed as a calculated parameter during iVAPS configuration.
MVe	Expiratory Minute Volume (MVe) is the product of the respiratory rate and expired tidal volume averaged over the last eight breaths. The measured MVe is displayed as a monitored parameter during ventilation.
MVi	Inspiratory Minute Volume (MVi) is the product of the respiratory rate and inspired tidal volume averaged over the last eight breaths. The measured MVi is displayed as a monitored parameter during ventilation.
Pressure	Pressure is the current airway pressure of the patient as measured at the patient port. The measured Pressure is displayed as a monitored parameter during ventilation.
PEEP	End expiratory pressure (PEEP) is the airway pressure measured 50 ms prior to the end of the last expiration. The measured PEEP is displayed as a monitored parameter during ventilation.
Pmean	Mean airway pressure of the patient over the last breath.
% Spont cycle	% Spont cycle is the percentage of breaths that are spontaneously cycled over the past 20 breaths.
% Spont trig	% Spont trig is the percentage of breaths that are spontaneously triggered over the last 20 breaths. The measured %Spont Trig is displayed as a monitored parameter during ventilation.
PIF	Peak Inspiratory Flow (PIF) is the maximum flow reached during the last inspiration. The measured PIF is displayed as a monitored parameter during ventilation. The expected PIF is calculated and displayed for volume controlled breaths on the settings screens when the Inspiratory Phase Duration Option is set to Ti.
PIP	Peak Inspiratory Pressure (PIP) is the maximum airway pressure reached during the last inspiration. The measured PIP is displayed as a monitored parameter during ventilation.
Pulse rate	The measured Pulse rate (pulse) is displayed as a monitored parameter when a pulse oximeter is used.

Parameter	Definition
Resp. rate	Respiratory rate (Resp. rate) is the number of breaths per minute averaged over the last eight breaths. The measured Resp. rate is displayed as a monitored parameter during ventilation.
RSBI	Rapid Shallow Breathing Index (RSBI) is calculated by dividing the breath rate by Tidal Volume. The measured RSBI is displayed as a monitored parameter during ventilation.
SpO <sub>2</sub>	The measured functional Oxygen Saturation (SpO <sub>2</sub> ) is displayed as a monitored parameter when a pulse oximeter is used.
Te	Expiratory time Te is the period in seconds of the last expiratory phase.
Ti	Inspiratory time Ti is the period in seconds of the last inspiratory phase. The measured Ti is displayed as a monitored parameter during ventilation. The expected Ti is calculated and displayed for volume controlled breaths on the settings screens when the Inspiratory Phase Duration Option is set to PIF.
Va	Alveolar Minute Ventilation (Va) is calculated by (Tidal Volume - Deadspace) x Resp. Rate. The measured Va is shown as a monitored parameter during ventilation.
Vte	Expiratory Tidal Volume (Vte) is the volume expired during the last breath. The measured Vte is displayed as a monitored parameter during ventilation.
Vti	Inspiratory Tidal Volume (VTi) is the volume inspired during the last breath. The measured VTi is displayed as a monitored parameter during ventilation.
Average Vt	Average Tidal Volume (Average Vt) is the average volume expired during the last five minutes of ventilation. The Average Vt is displayed as a calculation parameter during iVAPS configuration.
Average Vt/kg	Average Tidal Volume per kg (Average Vt/kg) is the Average Vt divided by Ideal Body Weight (IBW). The Average Vt is displayed as a calculation parameter during iVAPS configuration.



**ResMed Pty Ltd**

MANUFACTURER 1 Elizabeth Macarthur Drive, Bella Vista NSW 2153 Australia

See ResMed.com for other ResMed locations worldwide. Astral, AirView and ResScan are trademarks and/or registered trademarks of the ResMed family of companies. For patent and other intellectual property information, see ResMed.com/ip. Aerogen and Aeroneb are registered trademarks of Aerogen, Inc. NONIN is a trademark of Nonin Medical, Inc. Velcro is a trademark of Velcro Industries B.V. © 2018 ResMed. 278552/1 2018-05

ResMed.com