

BiWaze[®] Cough SYSTEM

USER MANUAL



Contents

1	Introduction	1
1.1.	Intended Use	2
1.2.	Contraindications	2
1.3.	General Warnings and Cautions.....	2
2.	BiWaze Product Overview	5
2.1.	System Overview	5
2.2.	Symbols.....	8
2.3.	Traveling with the System	10
2.4.	How to Contact ABM Respiratory Care	10
3.	Therapy Modes and Features.....	11
3.1.	Therapy Modes	11
3.2.	Therapy Features.....	12
4.	Therapy Setup.....	13
4.1.	Position the Device Properly.....	13
4.2.	Standard breathing circuit	13
4.3.	Supply Power to the Device	14
4.4.	Setup Therapy Modes	15
5.	Starting and stopping the therapy	17
6.	Viewing and Changing Settings	18
6.1.	Navigating the Menu Screens	18
6.2.	Auto Therapy Screen.....	19
6.3.	Accessing the Settings screen	20
6.4.	Accessing the Device Settings Screen.....	21
6.5.	Accessing the Administration Settings.....	24
6.6.	Modifying Patient Therapy Settings.....	25
6.7.	Viewing and Changing Device Settings.....	29
7.	Locking and Unlocking the device	36
7.1.	Locking options.....	36
8.	Cleaning and Maintenance	37

8.1.	Cleaning the Device	37
8.2.	Cleaning the patient port adapter	37
8.3.	Cleaning and Replacing the Air Inlet Filter	38
8.3.	Cleaning the Breathing Circuit.....	38
8.4.	Storage and transportation.....	39
8.5.	Preventive Maintenance	39
9.	Accessories	40
9.1.	Foot Pedal	40
9.2.	BiWaze Remote Control app.....	41
9.3.	Carrying Bag	43
9.4.	Device Cart	43
10.	Informational Messages.....	44
11.	Technical Specifications.....	45
11.1	Theory of operations	45
11.2	Part Numbers.....	49
11.3	Product Specification	49
11.4	Environmental.....	50
11.5	Physical	50
11.6	Standards Compliance.....	50
11.7	Device classifications.....	51
11.8	Wireless communication.....	51
11.9	Displayed Parameter Accuracy	52
11.10	Control Accuracy	53
11.11	Sound	53
11.12	Disposal.....	53
11.13	Essential Performance	54
12.	EMC Information	55
12.1	Guidance and Manufacturer's Declaration - Electromagnetic Emissions.....	55
12.2	Guidance and Manufacturer's Declaration - Electromagnetic Immunity	56

12.3	Guidance and Manufacturer's Declaration - Electromagnetic Immunity	58
12.4	Recommended Separation Distances between Portable and Mobile RF Communications Equipment and This Device	60
12.5	Guidance and Manufacturer's Declaration - Electromagnetic Immunity to Wireless Communications Equipment.....	61
12.6	Federal Communications Commission (FCC) Radiation Exposure Statement	61
13.	Trouble Shooting	62
14.	Limited Warranty	66
15.	Service Instructions	67
15.1	Expected Service Life	67
15.2	FRU and Spare parts	67
15.3	Planned Maintenance	67
15.4	Service Cleaning and Maintenance	67

1 Introduction

The BiWaze® Cough device helps to clear bronchopulmonary secretions from the respiratory system by providing a therapy which mimics a cough. The therapy consists of three phases which mimic a cough; inhale, exhale, and pause phase.

The inhale phase is positive airway pressure to expand the lungs. Then exhale phase is a sudden shift to negative pressure to pull the air out of lungs. Finally, the pause phase provides a rest before the next inhale phase. BiWaze allows for positive pressure to be delivered during the pause phase to keep the airways open in between the inhale and exhale phases.

This User Manual is applicable for the product “BiWaze® Cough” intended for a patient or care provider user.

Note: ABMRC LLC is the legal manufacturer of BiWaze Cough. ABMRC LLC is part of the corporate group, ABM Respiratory Care.

WARNING

Use BiWaze Cough only as directed by a physician or healthcare provider.

Use BiWaze Cough only for the intended use as described in this manual. Advice contained in this manual does not supersede instructions given by the prescribing physician.

Read the entire manual before using BiWaze Cough.

Ensure that latest revision of User Manual is being used. Contact ABM Respiratory Care or authorized local distributor to enquire about the latest revision of the User Manual. Any User Manual which is not the latest revision needs to be discarded.

Setup and configure BiWaze Cough in accordance with the instructions provided in this guide.

CAUTION (For USA only)

Federal law restricts this device to sale/use by or on the order of a physician.

1.1. Intended Use

This product is used for assisting patients to clear retained bronchopulmonary secretions by gradually applying positive pressure to the airway, then rapidly shifting to a negative pressure. This rapid shift in pressure, via a facemask, mouthpiece or an endotracheal or tracheostomy tube produces a high expiratory flow rate from the lungs, simulating a cough.

This device is designed for use on patients unable to cough or clear secretions effectively due to reduced peak cough expiratory flow, resulting from high spinal cord injuries, neuromuscular deficits or severe fatigue associated with intrinsic lung disease. This device is intended for use in hospital, institutional setting or in home on adult patients and pediatric patients 3 years old and above.

1.2. Contraindications

BiWaze Cough is contraindicated in patients with the following pre-existing conditions:

- known susceptibility to pneumothorax or pneumo-mediastinum
- severe bullous lung disease
- recent barotrauma

1.3. General Warnings and Cautions

The following are general warnings and cautions. Further specific warnings, cautions and notes appear next to the relevant instruction in the manual.



WARNING

- A WARNING alerts you to possible injury.
- The operator should read and understand this entire manual before using the device.
- BiWaze Cough is a restricted medical device intended for use by qualified, trained personnel under the direction of a physician.
- BiWaze Cough is not intended to be operated by persons (including children) with reduced physical, sensory or mental capabilities without adequate supervision by a person responsible for the patient's safety.

- If you notice any unexplained changes in the performance of this device, if it is making unusual or harsh sounds, if the device is dropped or mishandled, if water is spilled into the enclosure, or if the enclosure is broken, discontinue use and contact your home care provider.
- Therapy shall not be performed on a patient without a Bacterial/Viral (B/V) filter along the Breathing Circuit.
- Always use a new bacterial filter when using the device on a new patient.
- Confirm all settings before each treatment.
- Soreness and/or pain in the chest from a pulled muscle may occur in patients using BiWaze Cough for the first time if the positive pressure used exceeds pressures which the patient normally receives during Positive Pressure Therapy. Such patients should start at a lower positive pressure during treatment, and gradually increase the positive pressure used based on patient tolerance and comfort.
- Do not use the device in the presence of a flammable anaesthetic mixture in combination with oxygen or air, or in the presence of nitrous oxide.
- Therapy should not be initiated while the device is in Carry Bag.
- Do not remove the top cover or disassemble the device as there are no serviceable parts inside. The device should be serviced by authorized personnel only.
- Do not modify this equipment. No modification of this equipment is allowed by any unauthorized personnel.
- Only ABM Respiratory Care supplied accessories and consumables like Power Cord, Breathing Circuits, Foot Switch, etc. should be used for optimum performance of the device.
- Keep the young children away from the power cable, breathing circuit and connectors to prevent any choking or strangulation.
- If connected, disconnect the foot pedal remote after use from the device to avoid tripping.

CAUTION

A CAUTION explains special measures for the safe and effective use of the device.

- Do not expose the device to excessive force, dropping or shaking.
- Keep the power cord and device away from any potential heat sources like room heater, hot iron, kettle steam etc.
- Shut down the device when not in use
- Make sure that all the air inlets at the side of the device are unobstructed. If the device is put on the floor, make sure the area is free from dust and clear of bedding, clothes or other objects that could block the air inlets.
- Do not operate the device while it's in the carrying case.
- Do not operate the device in direct sunlight for better visibility and avoid heating the LCD screen.
- Hair from pets, spillage of food and infestation by pests can cause the device to have clogged filters. Keep the device away from children, pets and ensure that operating and storage environment is free from any pests.
- Do not operate the device in very dusty environment outside the room or in an environment with small fibres or airborne material which can clog the filters.
- The device has an Ingress protection rating of IP21, it can withstand minor vertical spills and wiping for cleaning. Do not splash/spray water or submerge the device in water.
- Disconnect the foot pedal and store it safely after user to avoid tripping on it.

Note: This product does not contain natural latex rubber.

2. BiWaze Product Overview

The BiWaze Cough includes the following components.

Product Package

- BiWaze Cough device
- Breathing circuit kit that includes a bacterial/viral filter, breathing tube, connector, and patient interface (face mask, mouthpiece, or flexible adapter for a trach)
- Patient port adapter
- Carrying Case
- AC Power Cord
- User Manual
- Air Inlet Filter

2.1. System Overview

BiWaze Cough helps patients in clearing excessively retained bronchopulmonary secretions in the lungs and upper airways. This is done by progressively applying positive pressure to the airway and then rapidly shifting to a significant negative pressure. This action replicates the effects of a natural cough and thereby helping in removal of secretions retained in the airways.

2.1.1 Main Control Interfaces

The items numbered in the illustration below are described in the table that follows.

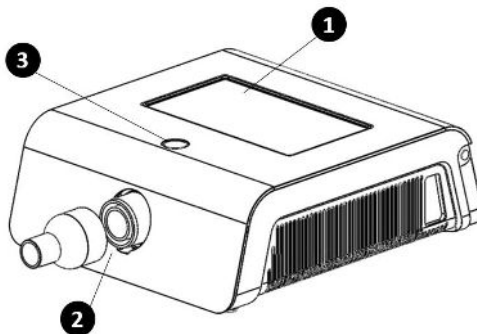

SI No	Item	Description
1	Touch Screen	The touch screen allows you to view and edit therapy settings, system status information, real-time patient data, and logs.
2	Patient Port and patient port adapter	The breathing circuit is connected to this port for therapy delivery through the patient port adapter.
3	Device Mode LED Light	This LED light provides different colour code lights. Green: Manual Mode Blue: Auto Mode Red: Error or shutdown mode

2.1.2 Back Panel Interfaces

The items numbered in the illustration below are described in the table that follows.

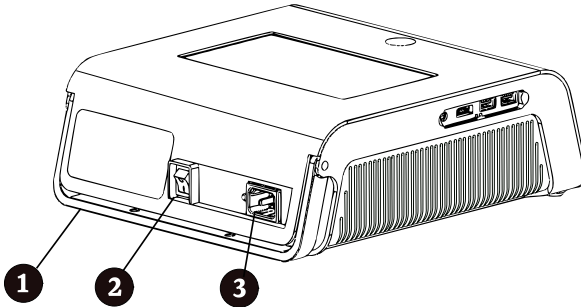

SI No	Item	Description
1	Handle	Handle to carry the device
2	Power source switch	Cuts off AC mains and battery power to the main processor
3	AC Power Inlet	AC power cord connection

2.1.3 Side Panel Overview

The items numbered in the illustration below are described in the table that follows.

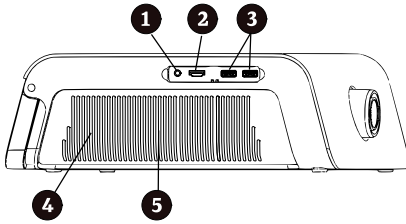

Device Left Side

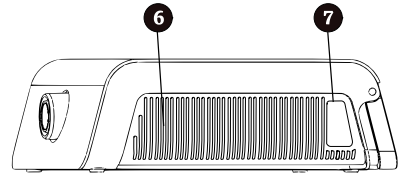

Device Right Side

Sl No	Item	Description
1	Foot Pedal port	Connection port for Foot Pedal
2	HDMI port	External HDMI display
3	USB ports	USB memory sticks and SpO2
4	Air outlet	Outlet port for expiratory air
5	Power supply cooling Fan location	Cooling fan for the power supply
6	MCB Fan	Main control board fan
7	Air Inlet Filter	Inlet port for inspiratory air

 **CAUTION:** Do not attach any unapproved devices or storage medium to any of the ports. Use only ABM Respiratory Care approved and supplied parts. Failure to do may damage the system.

2.1.4 Bottom Panel Features

The items numbered in the illustration below are described in the table that follows.

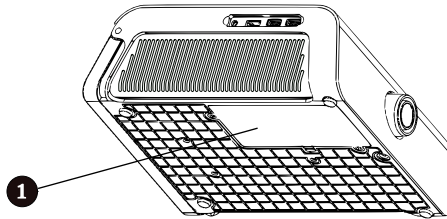







SI No	Item	Description
1	Battery housing	Internal battery

















WARNING: Do not open the battery cover, only authorized service personal can open and replace the battery. Do not try and use any other batteries, other than supplied by ABM Respiratory Care.

2.2. Symbols

The following symbols appear on this device.

	AC Power
	Remote Control
	USB Connector
	Type BF Applied Part
	Class II (Double Insulated)
	Power On/Power Off
IP21	Protected against solid objects over 12.5mm (e.g., a finger) and protected against vertically falling drops of water or condensation

	Marking of electrical and electronic equipment in accordance with article 11(2) of Directive 2002/96/EC (WEEE). Should not be disposed in landfill.
	Temperature limit
	Follow instructions for use
	Date of Manufacture
	Catalogue Number
	Authorized representative in European community
	Product serial number
	FCC marking
	Prescription use only
	Manufacturer*
	Stand-by
	CE Marking
	CAUTION
	WARNING

**The year of manufacture is written under this symbol on the BiWaze Cough device.*

2.3. Traveling with the System

It may be helpful to bring this manual along to help security personnel understand the device.

If you are traveling to a country with a line voltage different than the one you are currently using, a different power cord or an international plug adapter may be required to make your power cord compatible with the power outlets of the country to which you are traveling.

2.4. How to Contact ABM Respiratory Care

For customers in USA, contact ABM Respiratory Care Customer Service; 877-ABM-RC01 (877-226-7201) or customer.service@abmrc.com.

For customers in Asia, contact ABM Respiratory Care Customer Service via WhatsApp at +65 6428 6218 or customer.service.asia@abmrc.com.

For customers in Europe, the Middle East and Africa, contact ABM Respiratory Care Customer Service via customer.service.emea@abmrc.com.

3. Therapy Modes and Features

3.1. Therapy Modes

Therapy	Description
Manual	<p>Manual mode delivers therapy based on the Pause Pressure, Inhale and Exhale Pressure. The device delivers the set Inhale Pressure or Exhale Pressure for the amount of time that either the “+” or “-” button is pressed respectively. The device delivers Pause Pressure when neither button is pressed.</p>
Auto	<p>Auto mode delivers therapy based on the following prescription settings: Inhale Pressure, Inhale Time, Exhale Pressure, Exhale Time, Pause Pressure, Pause Time and Number of Cycles. Auto mode delivers pressure in the following sequence, repeating the sequence until the user pauses and exits the therapy, or the number of cycles count is reached:</p> <ul style="list-style-type: none">• Pause pressure for the duration of the Pause Time setting.• Positive pressure at the Inhale Pressure setting for the duration of the Inhale Time setting.• Negative pressure at the Exhale Pressure setting for the duration of the Exhale Time setting. <p>When the Inspiratory Trigger feature is enabled, Auto mode delivers pressure in the following sequence, repeating the sequence until user pauses and ends the therapy, or the number of cycles count is reached:</p> <ul style="list-style-type: none">• Pause pressure until the device detects the next inspiratory effort or the pause phase times out after 30 seconds.• Positive pressure at the Inhale Pressure setting when the device detects the patient’s effort to inhale for the duration of the Inhale Time setting.• Negative pressure at the Exhale Pressure setting for the duration of the Exhale Time setting. <p>Note: The therapy is paused when the device doesn't detect the patient's inspiratory breath.</p>

3.2. Therapy Features

The device provides the following therapy features:

3.2.1. Inspiratory Trigger

An important characteristic of the device is its ability to trigger on the patient's inspiratory breath to help synchronize the therapy with the patient's natural breathing, so it is more comfortable for the patient.

The inspiratory trigger feature is available when the device is in Auto mode. The pressure delivery sequence is synchronized with the patient's effort to inhale.

When the inspiratory trigger setting is activated in Auto mode, the inhalation breath will be delivered when the patient's inhalation effort is detected. If the patient effort is not detected within 30 seconds, the therapy is automatically paused.

There are 10 levels of sensitivity that can be adjusted per the patient's level of effort. It is recommended to start at the setting of 1 (least sensitive) and as the patient's inhale becomes weaker, the sensitivity level can be adjusted incrementally. Level 10 is the most sensitive.

Note: When inspiratory trigger is enabled, the Pause Time setting is disabled, and the user cannot adjust the Pause Time setting.

3.2.2. Oscillations

The Oscillation therapy feature delivers an oscillatory therapy based on frequency and amplitude settings. Use of the oscillation feature enhances mobilization and improves bronchial drainage.

Note: The oscillations will be least apparent to the patient with lower amplitude and higher frequency settings.

4. Therapy Setup

Review the following steps to prepare the device for the therapy.

Note: If the device was stored in temperature below 40 F (5 °C) or 95 F (35 °C), allow the device to normalize for 15 minutes at room temperature (~20 °C) before using the device.

4.1. Position the Device Properly

Position the device on a firm, flat surface within arm's length of the patient or device operator. The device should be placed below elbow level for the best visibility of the screen. Make sure that the air inlet areas on the left and right of the device are not blocked. Air must flow freely around the device for the system to work properly.

4.2. Standard breathing circuit

- a. Standard bacterial filter
- b. Optional 22mm connector
- c. Standard 6 feet long, 22 mm diameter single tube

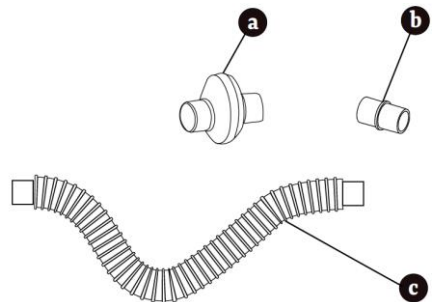

Assemble the standard breathing circuit

1. Ensure that standard 22mm patient port adapter is attached to the device.
2. Connect the bacterial / viral filter to the breathing tube
3. Attach bacterial / viral filter to the patient port adapter

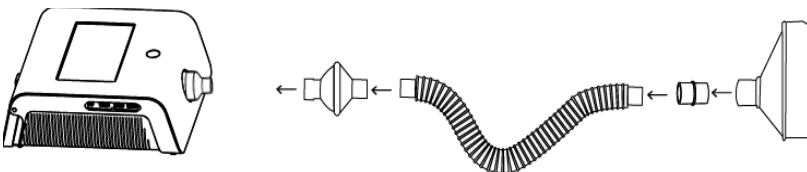

4. Attach the patient interface (face mask, mouthpiece, or flexible trach adapter) to the breathing tube. Use appropriate adapters between the breathing tube and patient interface if needed.

- Breathing tube diameter needs to be 22mm per ISO 5356-1 standard
- B/V filter to have at least 99.99% bacterial/viral filtration efficiency
- Face masks to be of suitable size with air cushion

4.3. Supply Power to the Device

The device can operate on external AC power or built-in battery when charged.

4.3.1. Using AC Power

An AC power cord is included with the device.

- a. Plug the socket end of the power cord into the AC inlet on the back of the device.
- b. Plug the pronged end into an electrical outlet not connected to a wall switch.

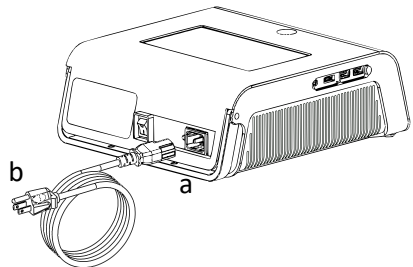

Note: Ensure that all connections are secure.

4.3.2. Internal Battery

BiWaze Cough has an internal Lithium-ion battery pack for the device.

Battery can power the device with active therapies for up to 2 hours* on full charge.

*subjected to default settings, the actual run time can vary depending on age of the battery, settings and actual active therapy time.

The internal battery can charge simultaneously while the device is operating on the AC power and switches to battery power source when AC power is disconnected.



Note: The battery shall be fully charged before using the device for the first time or when device is unused for an extended period of time.

Disposal: Do not dispose the battery in landfill.

4.3.3. Device Power Source Indicators

Power source indicators are presented on the device and the display screen. These indicators are described in detail below.

4.3.3.1. AC Power Indicators

When AC power is applied to the device and the display is off, a red AC LED indicator on the Power On/Power Off switch illuminates. When AC power is applied and the display is on, a charging indicator  icon appears on the battery symbol on top menu bar. The battery charging indicator  icon disappears when the device is run on battery power.

4.3.3.2. Battery Level Indicators

When the battery is connected to the device, battery symbols will appear on-screen to indicate the battery status. The shading in the battery icon indicates the power remaining in the battery.

4.4. Setup Therapy Modes

Note: BiWaze Cough does not require any system pre-checks before use.

4.4.1. Manual Therapy Mode

1. Switch on the power at the back of the device.

Note: The device may take up to 30 seconds before the therapy screen is presented and device is ready for use. During this time the device is self-calibrating.

2. Confirm the therapy settings before starting therapy.
3. Assemble and attach the breathing circuit to the device. Press the therapy start button  on the touch screen to begin therapy.
4. Press the “+” button on touch screen to deliver an inhale breath with one finger.
5. Quickly switch to pressing the “-” button with second finger simultaneously lifting the finger from the “+” button to begin the exhale breath.

6. The pause phase will engage if no buttons are pressed. Repeat the inhale and exhale steps above until the patient's secretions are cleared or as prescribed. After the therapy is completed, disconnect the breathing circuit from the device, and clear secretions that may have become visible in the mouth, throat, tracheostomy tube, or endotracheal tube.

4.4.2. Auto Therapy Mode

1. Switch on the power at the back device.
2. Confirm the therapy settings before starting therapy.
3. Assemble and attach the appropriate breathing circuit to the device. Press the start button on the touch screen to start therapy.
4. The device will automatically cycle from Pause, Inhale, and Exhale. The cycle will restart with Pause, Inhale, and Exhale until all the programmed cough cycles complete.
5. After the therapy is completed, disconnect the breathing circuit from the device, and clear secretions that may have become visible in the mouth, throat, tracheostomy tube, or endotracheal tube.

4.4.3. Therapy Profiles

When setting the device up for the patient, the health care professional can define up to ten profiles under each therapy mode (Auto and Manual). Profiles allow the user to quickly select a group of prescribed settings to apply therapy. See *Section 6.3 – Accessing the settings screen* for more information on how to save a therapy profile.

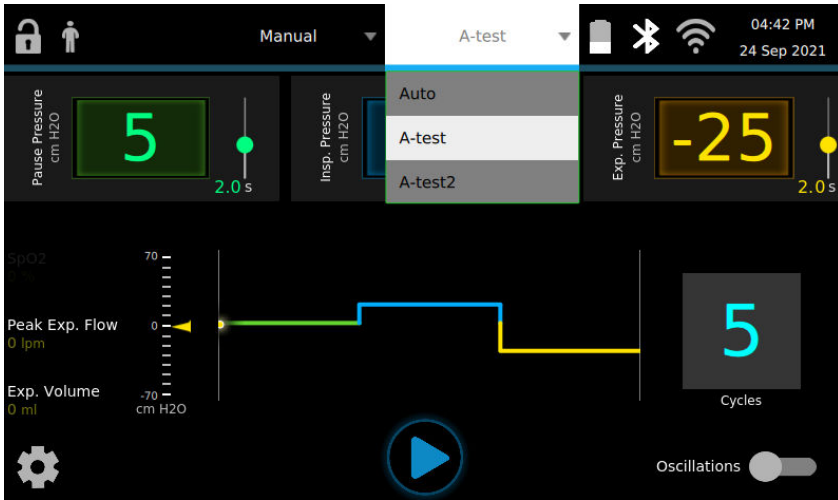

4.4.4. Selecting a profile

User can select available profiles under each mode (Auto/Manual) from the top ribbon menu bar.



5. Starting and stopping the therapy

 **CAUTION:** Ensure the Breathing circuit and the patient port adapter are dry before delivering the therapy.

- User can start the therapy by touching the “Start Therapy”  Button on the main screen.
- User can pause the therapy by touching the “Pause Therapy”  Button on main screen while therapy is ongoing.
- User can RESUME THERAPY or END NOW from the Therapy Paused screen.

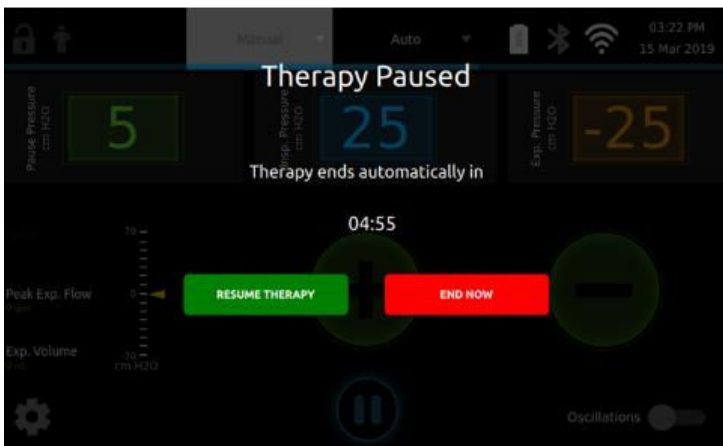

Note: If user does not resume or end the therapy while paused, the system automatically ends the therapy after the time expires.

6. Viewing and Changing Settings

6.1. Navigating the Menu Screens

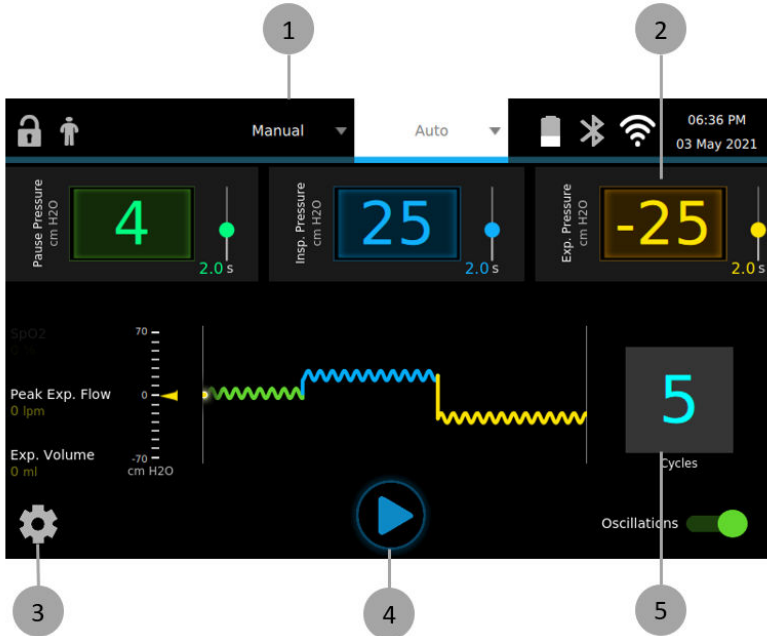

1. Therapy Mode Selection (Manual and Auto)
2. Auto Therapy Pressure and Time Settings
3. Additional Therapy and Device Settings
4. Start /Pause Therapy
5. Number of Cycles

6.1.1. Timeout Periods

The following timeout events may occur on the device:

Auto Therapy Pause: Has a timeout period of 5 minutes. If the user pauses the therapy and doesn't resume it after 5 minutes the device ends the therapy and displays the "therapy complete" message.

Manual Mode Therapy Pause: Has timeout of 5 minutes if the user leaves the device untouched without shifting to positive or negative breath. The

user can resume the therapy or after 5 minutes the device will end the therapy.

Manual mode + and -: If the user continues to touch + or – button for longer than 10 seconds the device will go into a Therapy Paused state.



Confirmation Messages: Confirmation messages can only be removed by touch and have no auto timeout.

6.2. Auto Therapy Screen

When you switch on the power at the back of the device, the start screen appears momentarily with the manufacturer’s logo.

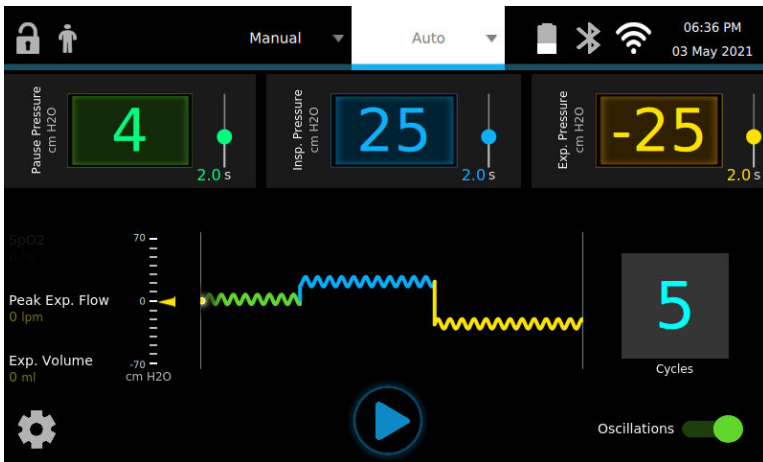
The Auto Therapy screen displays the date and time, Wi-Fi and Bluetooth connection status, therapy mode menu, power source and battery indicator, optional Patient ID field, auto therapy settings and measurements.



1. Check if the device is in Unlocked or Locked status with  /  icon.
2. Change Therapy mode or select a Profile.
3. Check if the AC power charging with the icon on top of the battery  icon.
4. Check the battery charge status.
5. Enable/Disable a Bluetooth connection.
6. Enable/Disable Wi-Fi and connect to a network.
7. Change therapy pressure and time settings .
8. Enable/Disable Oscillations.

Note: Oscillations can be toggled on and off, even while therapy is ongoing.

- 9. Pressure manometer.
- 10. Start/Pause the therapy.

6.3. Accessing the Settings screen

The Therapy Settings screen appears after you touch the settings icon  on bottom left corner of the screen.

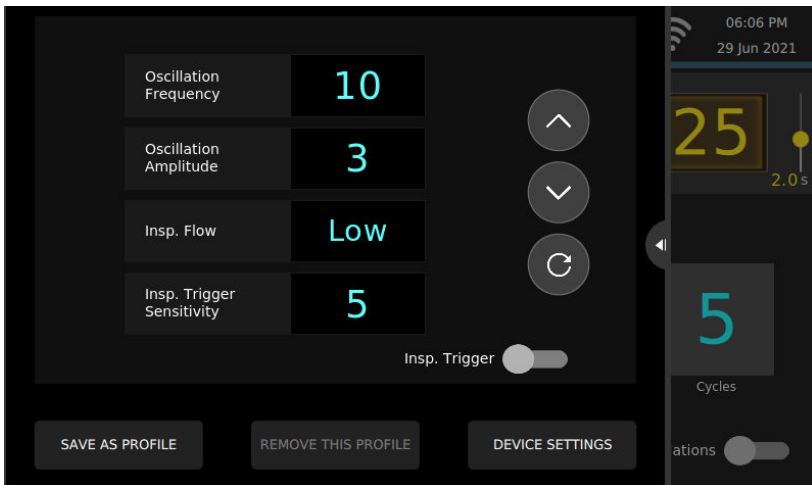

You can perform the following actions from the settings screen:

- Set oscillation frequency and amplitude
- Set inspiratory flow level

Set inspiratory trigger sensitivity

- Save current settings as pre-set profile or remove a pre-set profile
- Access Device settings

Setting	Description
Add/Remove Profiles	Allows you to save currently selected settings as profile as pre-sets for quick select. User can also remove currently selected profile from this screen.
Inspiratory Trigger toggle	Allows you to Enable/Disable the inspiratory trigger. If the inspiratory trigger is on, the pause time setting is

	overridden as the device trigger inspiratory phase from pause phase of breath only when it detects an inspiratory effort.
Inspiratory Trigger Sensitivity	Allows you to choose between sensitivity in range of 1-10 with 10 being most sensitive. User can update this setting to adjust sensitivity of trigger. It is recommended to start at 1 (least sensitive) and increase sensitivity as needed.
Inspiratory Flow	This setting allows user to select between low, medium and high inspiratory flow.
Oscillation Amplitude	Allows user to set the oscillation amplitude in range from 1 to 5 with 5 being higher amplitude. Refer to <i>Oscillations Control under Section 11.1</i>
Oscillation Frequency	Allows user to select frequency of oscillation in range of 5-20Hz with increments of 1 Hz

6.4. Accessing the Device Settings Screen

You can access the Device Settings screen by following the settings icon  > DEVICE SETTINGS button

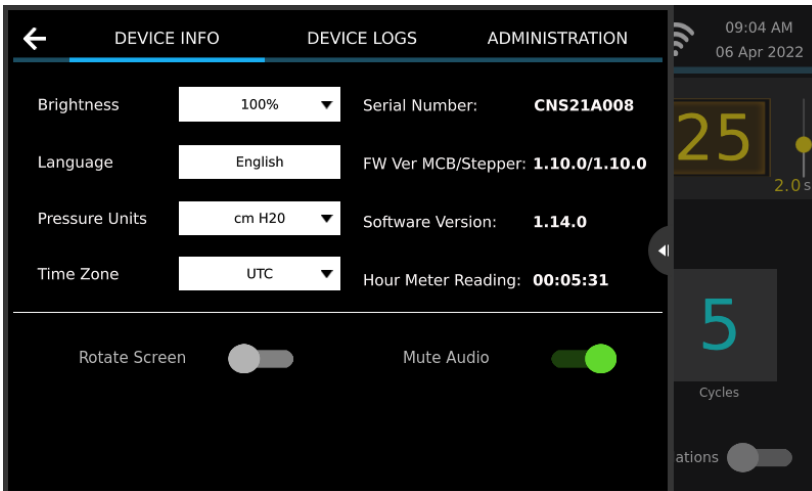

The following items are available in Device settings:

- Serial number of the device
- Firmware and Software Versions of the device
- Hour Meter Reading
- Set device display brightness
- Select device language
- Change Time Zones
- Check Device Logs
- Access the Administration settings

The device logs are accessible by selecting the DEVICE LOGS tab.

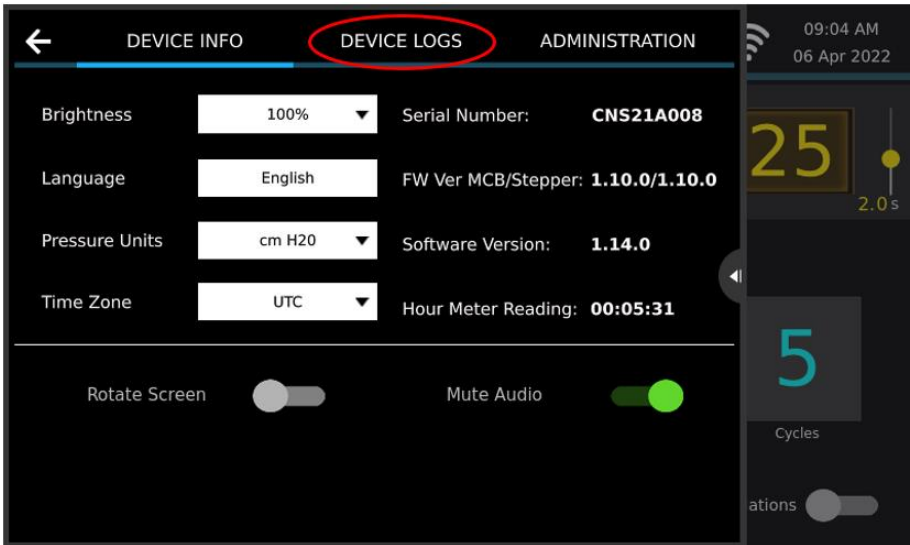

The device log separates the information into three sections:

Note: All log files in BiWaze Cough reflect an internal clock that is in UTC and is not changed by the date/time that is changeable on the main screen.

1. System log

Displays system level events which have occurred in device. such as updates to WIFI settings or Date/time. The fields in this log include: time of occurrence, type of event and value(e.g., Time, Date, WI-FI state etc.,).

SYSTEM LOGS		MONITORING LOGS		TECH LOGS	
Time Stamp	Event ID	Log Type	Event Type	Value	Ref ID
2022-03-05 11:50:00 am	51	DEVICE	TIME_CHANGED	11:50	
2022-03-05 10:50:13 am	50	DEVICE	DATE_CHANGED	05 Mar 2022	
2022-03-04 10:48:00 am	49	DEVICE	TIME_CHANGED	10:48	
2022-03-04 10:48:52 am	48	DEVICE	DATE_CHANGED	04 Mar 2022	
2022-03-04 10:47:40 am	47	DEVICE	DEVICE_POWER_ON	evt_val:1	
2022-03-04 10:44:48 am	46	DEVICE	DEVICE_POWER_ON	evt_val:1	
2022-03-04 10:32:00 am	45	DEVICE	DEVICE_POWER_ON	evt_val:1	

PREVIOUS CLOSE NEXT

2. Monitoring log

Displays the therapy cycles performed. The fields in this log include time of occurrence, type of event and cycle value (e.g., peak expiratory and expiratory volume etc.,).

SYSTEM LOGS		MONITORING LOGS		TECH LOGS	
Time Stamp	Event ID	Log Type	Event Type	Value	Ref ID
2022-03-04 10:19:31 am	40	MONITOR	CYCLE_MEASUREMENT	≈:0,E_V:0,SPO2:fc	32
2022-03-04 10:19:29 am	38	MONITOR	CYCLE_MEASUREMENT	≈:0,E_V:0,SPO2:fc	32
2022-03-04 10:19:26 am	37	MONITOR	CYCLE_MEASUREMENT	≈:0,E_V:0,SPO2:fc	32
2022-03-04 10:19:23 am	35	MONITOR	CYCLE_MEASUREMENT	≈:0,E_V:0,SPO2:fc	32
2022-03-04 10:19:21 am	34	MONITOR	CYCLE_MEASUREMENT	F:0,E_V:0,SPO2:fc	32
2022-03-04 10:18:49 am	31	MONITOR	CYCLE_MEASUREMENT	!1,E_V:9035,SPO	11
2022-03-04 10:18:42 am	29	MONITOR	CYCLE_MEASUREMENT	.6,E_V:8472,SPO	11

PREVIOUS CLOSE NEXT

3. Tech log

Displays errors which have occurred in device. The fields in this log include time of occurrence, type of event/Error and value (like error codes).

Time Stamp	Event ID	Log Type	Event Type	Value	Ref ID
2022-03-30 06:48:44 am	45	ERROR	ERROR_STATE	evt_val:8000000	
2022-03-29 07:12:32 am	29	ERROR	ERROR_STATE	evt_val:7c	

PREVIOUS CLOSE NEXT

Note: To view the details of a log value, the user can press the Value field and a window will open to display the details. Also, the date is in YYYY-MM-DD format under Time Stamp field.

6.5. Accessing the Administration Settings

You can access the Administration settings by following the settings icon  > DEVICE SETTINGS button > ADMINISTRATION tab.

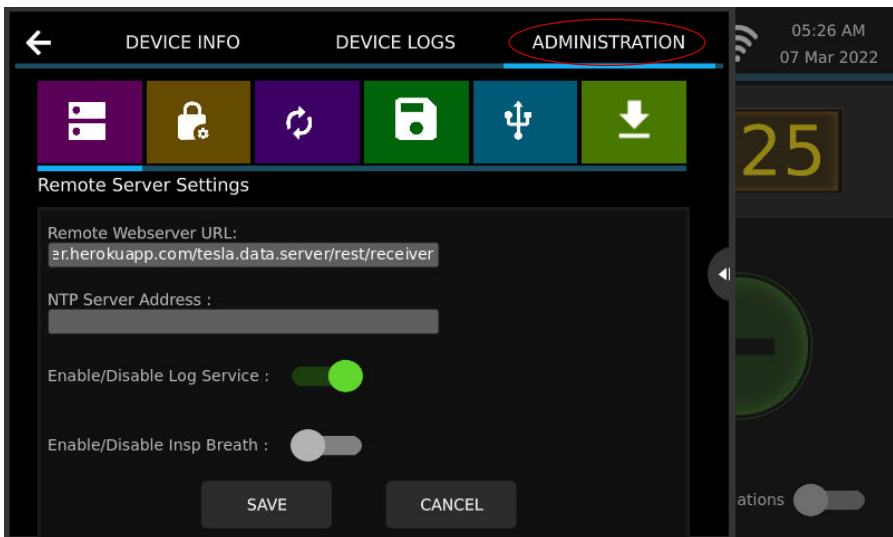

Note: This screen is password protected, only trained service providers should access this screen.

You can perform following actions from the Device Administration screen

- Turn on the ability to end a standard auto therapy on an inspiratory breath
- Download device logs to a USB disk
- Download device settings to a USB disk
- Upload/program a device with settings from a USB disk
- Configure Remote server for remote logging
- Configure lock limit adjustments
- Reset to default settings

6.6. Modifying Patient Therapy Settings

6.6.1. Auto Therapy settings

From the Auto Therapy screen, the following settings may appear on-screen, depending on how the device is configured.

Note: When a device is Locked with a red padlock, the therapy pressures are not editable. There is an option to allow adjustments to therapy with a limit of <5 cmH₂O and ± 2 seconds.

Setting	Description
Modes and Profiles	Allows you to quickly select a group of predefined prescription settings under each mode (Manual or Auto).
Oscillations Toggle	Allows you to Enable/Disable the oscillations. Oscillation creates the pressure pulses delivered to the patient based on Frequency and Amplitude settings.
Inspiratory Pressure	Allows you to set the Inspiratory Pressure setting from 0 to 70 cmH ₂ O in increments of 1. The Inhale Pressure is the pressure the patient receives while in the Inhale phase. User can adjust flow pattern for inspiratory phase from Advance Therapy Settings.
Inhale Time	Allows you to set the Inhale Time from 0.0 to 5.0 seconds in increments of 0.1. Inhale Time indicates how long the patient spends in the Inhale phase when in Auto mode. This setting is not available when Therapy Mode is set to Manual.

Exhale Pressure	Allows you to set the Exhale Pressure from 0 to -70 cmH2O in increments of 1. Exhale pressure is the pressure the patient receives while in the Exhale Phase.
Exhale Time	Allows you to set the Exhale Time from 0.0 to 5.0 seconds in increments of 0.1. Exhale Time indicates how long the patient spends in the Exhale Phase when in Auto mode. This setting is not available when the mode is set to Manual.
Pause Pressure	Allows you to set the Pause Pressure from 0 to 15 cmH2O in increments of 1. Exhale pressure is the pressure the patient receives while in the Pause phase of breath.
Pause Time	Allows you to set the Pause Time from 0.0 to 5.0 seconds in increments of 0.1. This setting is not available when the mode is set to Manual or when Inspiratory Trigger is enabled in Auto Mode (see Advanced Settings)
Number of Cycles	Allows you to set number of cycles the device will deliver automatically in Auto Mode. This setting also acts as cycle count down once therapy is started in Auto Mode. In Manual Mode this field displays count of breath cycles completed.

You can edit any of the three pressure settings by touching corresponding setting.

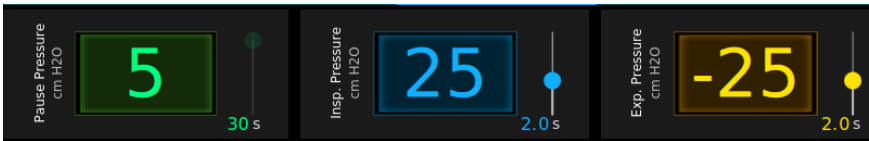

On touch you will be presented with following window

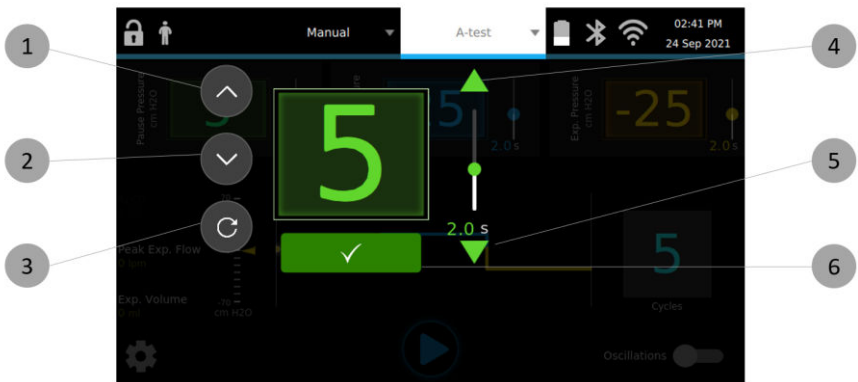

1,2,3 – Increment, decrement, reset the pressure setting

4,5 – Increment, decrement time setting

6 – Confirm the change

Note: The pressure and time settings are auto saved if the therapy was delivered with those settings.

6.6.2. Auto Mode – Advanced Therapy Programming

BiWaze Cough allows advanced therapy programming with the creation of custom therapies for patient based upon their need. Each custom therapy can be saved as a pre-set profile. A custom therapy may have inhale breaths for the first few therapy cycles and end with a big inhale breath. A custom therapy may have inhale breaths in the middle of the standard cough therapy. The custom therapies allow healthcare providers the ability to provide therapy for each patient's specific need. The advanced therapy programming is only available to setup and edit if the device is Unlocked.

6.6.2.1 Add or Edit Advanced Therapy Programming

1. From the Auto Therapy screen, ensure the number of cycles you want the Advanced Therapy to have is displayed in the Cycle count box.
2. Perform a long press on the therapy waveform to be brought into the Advanced Therapy Programming screen.

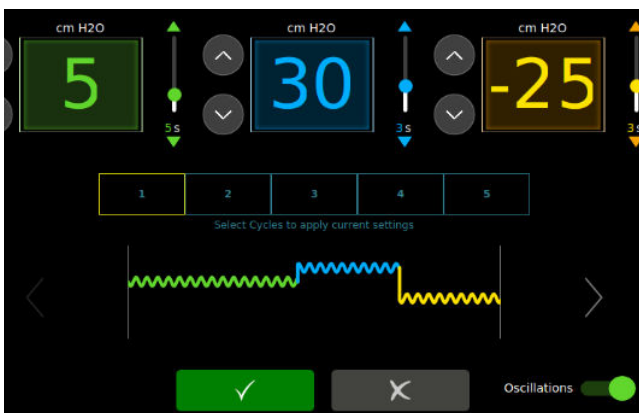

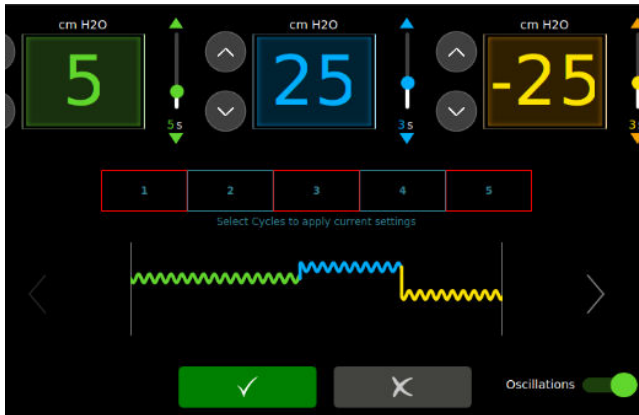

3. Select any breath cycle by touching the cycle number on the selection band. The selected cycle is highlighted in yellow on the selection band.
4. Change the settings of selected cycle. The Pause, Inhale, and Exhale settings can have their pressure and time modified.
5. Press before selecting a different cycle to save the changes made.
6. Once a cycle is changed, it can be copied to other cycles to speed up programming. To copy, perform a long press of a selected cycle in the selection band. The selected cycle turns "red" to highlight copy mode.
7. Once the "copy mode" is enabled user can select multiple cycles on the cycle selection band which will be highlighted in "red" to show selection.
8. Pressing will save the current settings to the selected cycles.
9. To close Advanced Therapy Programming, press .

6.7. Viewing and Changing Device Settings

6.7.1. Network settings

User can perform Bluetooth and Wi-Fi configuration from the main screen using the available icon on the top menu bar.

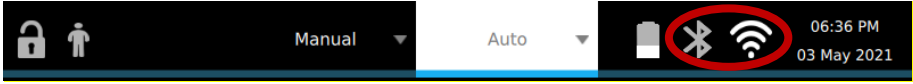

Bluetooth settings

- User can enable/disable the Bluetooth
- User can initiate the device to be open for pairing mode. Once selected the device stays in pairing mode for 5 minutes and then the pairing mode is switched off automatically.

Wi-Fi Settings

- User can enable/disable the Wi-Fi
- User can look for available networks and select one for connection
- Once Wi-Fi is connected, the IP address and MAC address is visible

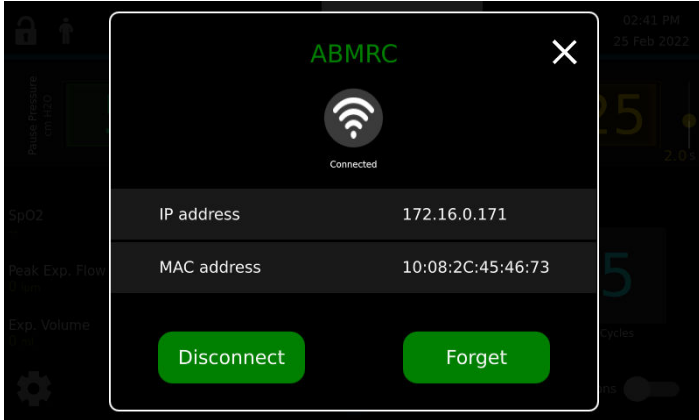

WARNING: Connecting the device to public or unknown networks could result in unidentified risks.

NOTE:

- If the network interfaces are connected to any unapproved systems user shall identify, analyse, evaluate and control any potential risks.
- Do not connect the device to unknown or public networks.

6.7.2. Device settings

User can bring up standard device settings from Settings  menu followed by selection of Device Settings button.

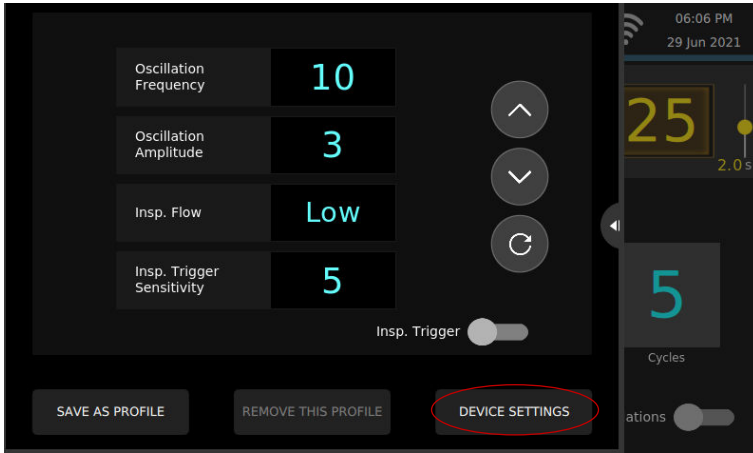

Following device settings are available for viewing and updating.

Setting	Description
Language	Select the language in which the software should appear.
Pressure Units	Select the pressure units that display on-screen. You can choose either cmH ₂ O, mbar or hPa. All pressure units that appear on-screen display in the unit of measure selected here.
LCD Brightness	Select the brightness of the screen backlight from 10%-100%, with 10% being the dimmest setting and 100% being the brightest.
Time Zone	A list of time zones is available.
HMR reading	Hour meter reading (HMR) displays the total time the device has delivered therapy.
Therapy logs	User can browse therapy logs in the log view panel on this screen.

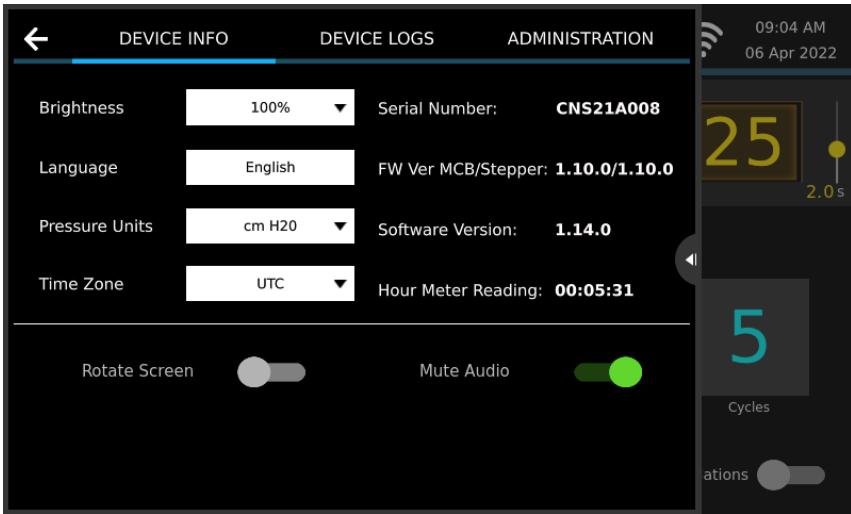

6.7.3. Administrative device settings

This screen is intended for use by trained service technicians. User can bring up administrative device settings from device settings menu by selecting “Administration” menu. User will be asked to enter admin password.



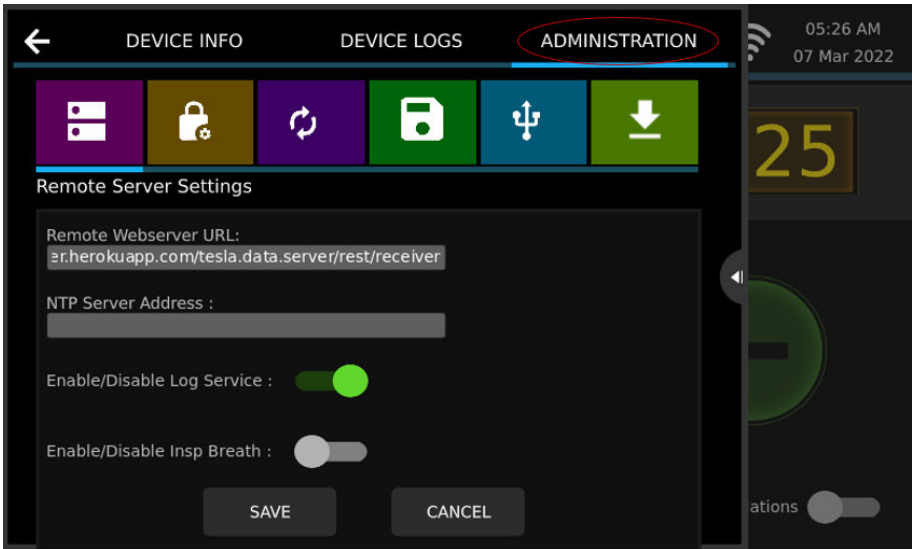

Following device settings are available for viewing and updating.

Setting	Description
Lock adjustment	Admin user can change settings limits allowed in locked mode
Remote server address	Remote web server address Update HL7 FTP server address here if available.
Download Therapy logs	Insert a USB disk in any of the two available slots in the device and download the therapy Logs.
Backup device Settings	Insert a USB disk in any of the two available slots in the device and download the device settings.
Restore Device Settings	Insert a USB disk in any of the two available slots in the device and upload the previously downloaded device Settings.
Reset to default	Reset the device to default settings.

6.7.4. Date and time

BiWaze Cough allows users to either sync the date and time with the current location by connecting to a WI-FI network or manually set the date and time (when not connected to Wi-Fi). The date and time set on the device is not reflected in the internal device logs which is set to Universal Time (UTC).

Note: BiWaze Cough will automatically sync the date/time when connected to WIFI so the manually set date/time will be overwritten.

To manually set the date;

1. Press on the date on the top right corner (as shown below)



2. Press the blue arrow next to Date

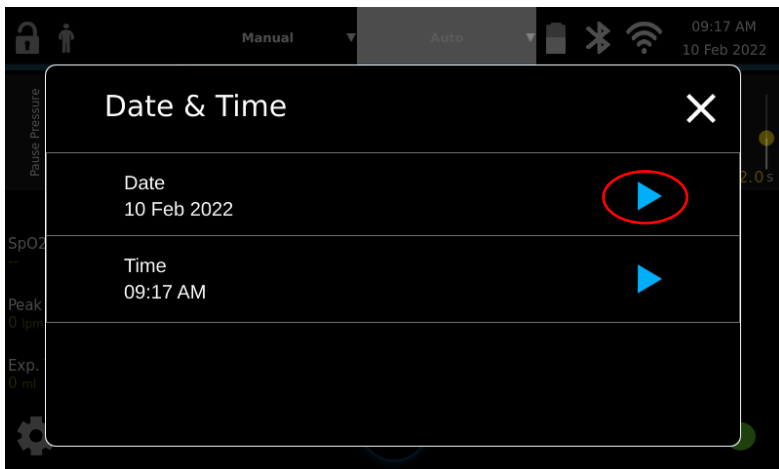

3. Use the arrow keys to increase or decrease the number

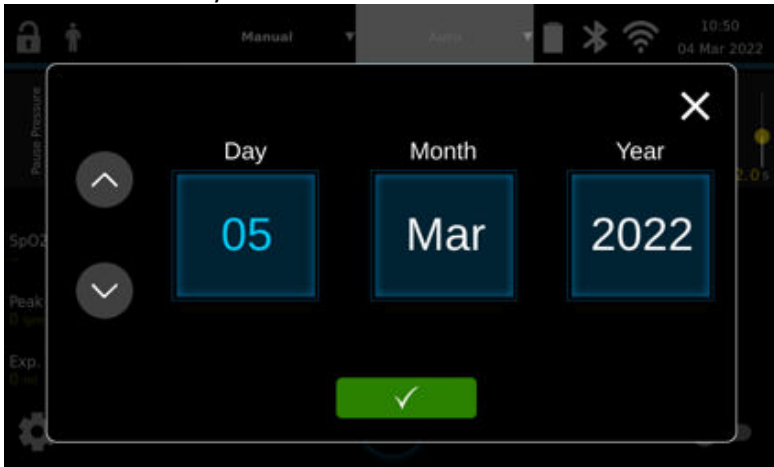

4. Press the  to save and close the date settings

To manually set the time;

1. Press on the time on the top right corner



2. Press the blue arrow next to Time

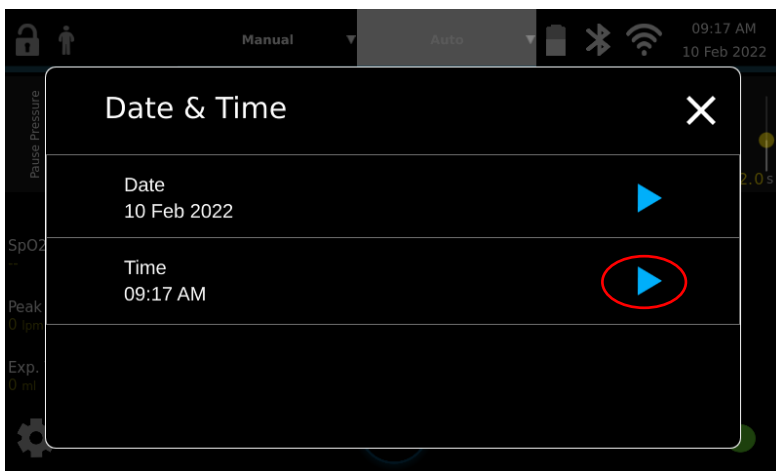

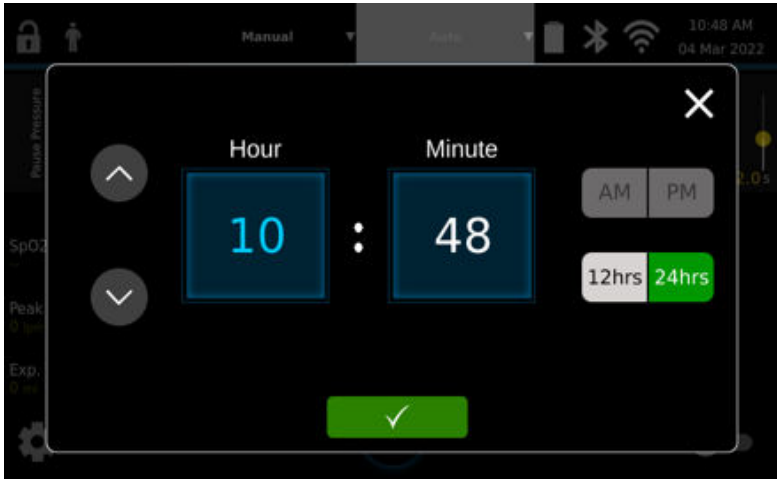

3. Select either Hour or Minute by pressing the number.



4. Use the arrow keys to increase or decrease the time
5. Select either 12 hour or 24-hour clock. If a 12-hour clock is selected, choose AM or PM
6. Press the  to save and close the time settings

7. Locking and Unlocking the device

The device is recommended to be Locked for home users. The information related to access and passwords are available to home care providers.

The lock menu is available on top left corner of the screen. The icon  shows when the device is locked and  when the device is unlocked. Touching the same icon starts the unlock/lock process.

7.1. Locking options

BiWaze Cough menus can be locked with limited flexibility to the home user. After the administrative password is entered the user is presented with following options before the lock operation is complete.

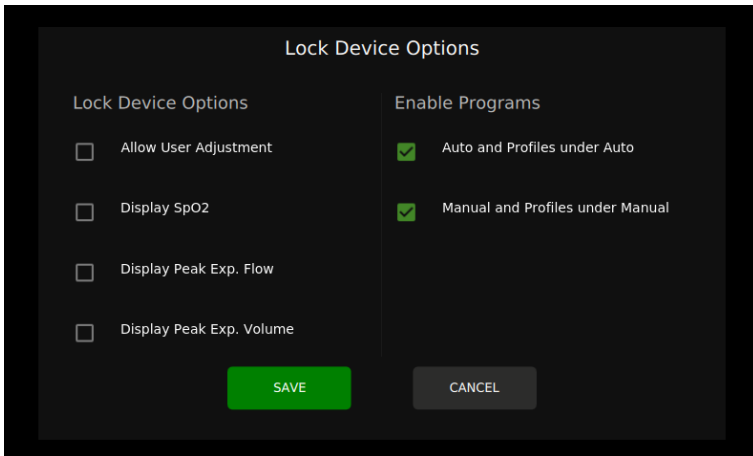

Options when locking the device include Determining which therapy modes, the home user can view (Auto, Manual, or both); Select if the home user is allowed to adjust pressure and time within set limits (5cmH20 for pressures, 2 seconds for time)

8. Cleaning and Maintenance

8.1. Cleaning the Device

 **CAUTION:** Remove the main power chord from the device and wall outlet before cleaning the device.

The device's exterior surface should be cleaned before and after each patient use and more often if needed.

Unplug the device and clean the front panel and exterior of the enclosure (excluding Breathing Circuit) as needed using one of the following cleaning agents:

- A clean cloth dampened with water and a mild detergent
- 70% Isopropyl alcohol
- DisCide Towelettes
- 10% Chlorine bleach solution

Inspect the device and tubing for damage after cleaning. Replace any damaged parts. Allow the device to dry completely before plugging in the power cord.

8.2. Cleaning the patient port adapter

After removing the Patient port adapter from the device, the patient port should be washed thoroughly with liquid dishwashing soap and water. These parts must completely air dry before reuse.

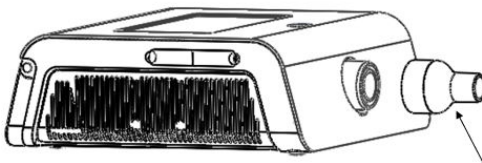

Patient Port adapter

8.3. Cleaning and Replacing the Air Inlet Filter

Under normal usage, you should clean the inlet air filter at least once every 1 month and replace it with a new one every six months.

- If the device is operating, stop the airflow. Disconnect the device from the power source.
- Remove the filter from the enclosure.
- Examine the filter for cleanliness and integrity.
- Wash the filter in warm water with a mild detergent. Rinse thoroughly to remove all detergent residue.
- Allow the filter to air dry completely before reinstalling it. If the filter is torn or damaged, replace it. Only filters from ABM Respiratory Care should be used as replacement filters.
- Reinstall the filter.

8.3. Cleaning the Breathing Circuit



WARNING: Do not sterilize the breathing circuit. Always use a new bacterial filter when using the device on a new patient.

8.3.1. Institutional (Hospital) Use

Breathing Circuit: Breathing Tube, Patient Interface and Connectors:

If the device is to be used by more than one patient, the breathing circuit must be replaced.

For a single patient use, the breathing tube and patient interface should be washed thoroughly with liquid dishwashing soap and water. These parts must completely air dry before reuse.

Note: Replace the breathing circuit after 30 days or 90 therapy cycles, whichever comes first

Bacterial/Viral Filter:

If the device is to be used by more than one patient, the bacterial filter must be replaced to prevent cross contamination.

For a single patient use, the filter, which protects the device from entraining foreign material from the patient, can be left in place if it is not blocked by sputum or trapped moisture. Do not try to wash the bacterial filter.

Note: For a single patient replace the breathing circuit after 30 days or 90 therapy cycles whichever comes first.

8.3.2. Home (Individual) Use

Breathing Circuit: Breathing Tube, Patient Interface and Connectors:

After use, the breathing tube and patient interface should be washed thoroughly with liquid dishwashing soap and water. These parts must completely air dry before reuse.

Note: Replace the breathing circuit after 30 days or 90 therapy cycles, whichever comes first.

Bacterial/Viral Filter:

The filter, which protects the device from entraining foreign material from the patient, can be left in place if it is not blocked by sputum or trapped moisture. Do not try to wash the bacterial filter.

Note: Replace the filter after 30 days or if it gets wet or clogged.

8.4. Storage and transportation.

While not in use cover the patient port with the cap provided at the port. Switch off the device and remove the power cable. Store in a dust free location outside the reach of children.

While transporting use the carry bag provided with the device. While travelling in airplane do not check in the device, carry it in cabin. Do not place other baggage on top of the device.

8.5. Preventive Maintenance

This device does not require routine servicing.

9. Accessories

There are several accessories available for BiWaze Cough. When using the accessories, always follow the instructions included with them.

9.1. Foot Pedal

You can use the Foot Pedal (BC20120) to deliver therapy in Manual Mode. The Foot Pedal can be connected to the Remote-Control Connector on the side of BiWaze Cough. See *Section 2.1.3* for port connection details.

Note: Therapy must be started from the main screen before the foot pedal can be used.

 **CAUTION:** Remove the Foot pedal from the device after use and store it safely to avoid entanglement or tripping.

Note: The Foot Pedal is an optional accessory and is not essential for functionality of the device

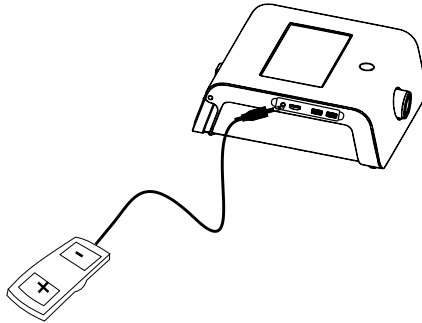

Once therapy is started in Manual mode from the main device, the foot pedal can be used as optional remote to apply manual mode therapy by initiating inhale (+ press), exhale (- press) and pause phase (no press).

9.2. BiWaze Remote Control app

You can use BiWaze Remote app as remote control to start and stop therapy as well as deliver therapy in Manual Mode.

9.2.1. Pairing the Remote Control app to the device

BiWaze Remote Control app must be paired with the device before it can be used. You can turn on the pairing from the Bluetooth menu on the device by enabling the “Pairable ON” toggle on the device. After this step, you can follow the steps in next section for connecting the app to the device.

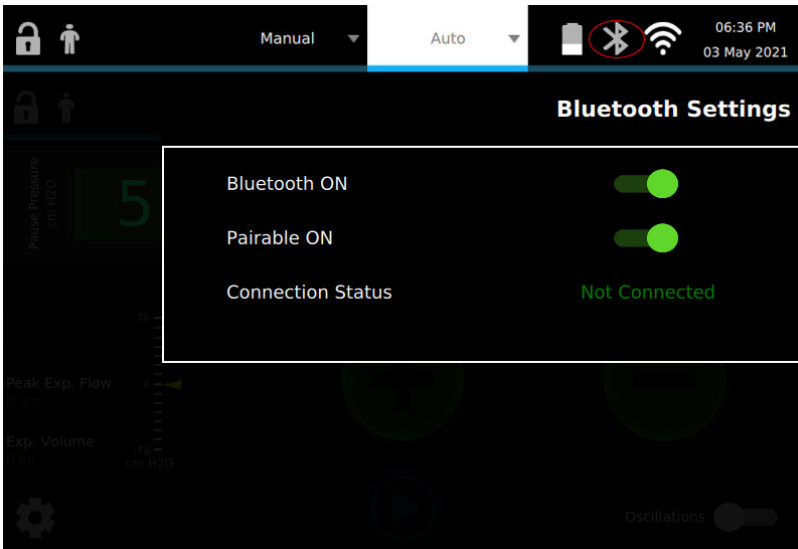

Note: For security purpose the ‘Pairable ON’ toggle button will be turned OFF automatically after 5 minutes if enabling manually. **You must follow this step only for the first time** you are connecting your mobile app to the device.

9.2.2. Connecting the BiWaze Remote Control app to the device

1. Ensure that Bluetooth is enabled on both the BiWaze device and the mobile phone. Connect the BiWaze Remote Control app to the BiWaze device. Press “Pair Device” button for the app to start searching nearby BiWaze devices. Select the required the device with respect to device serial number.

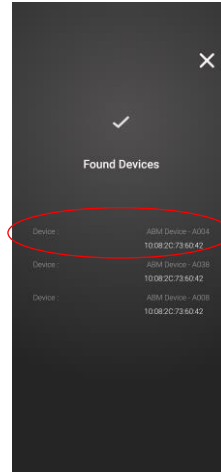
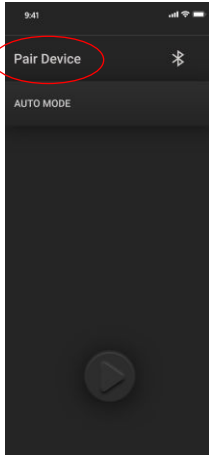

Please note that the ABM devices will appear with name “ABM Device – “ <last 4 digits of device serial number>

2. Once connected the main screen will show status as connected and the current mode from BiWaze device.

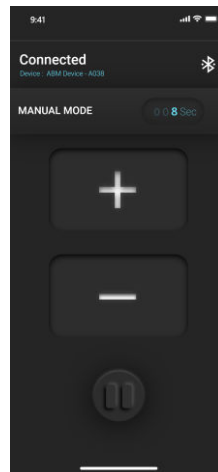
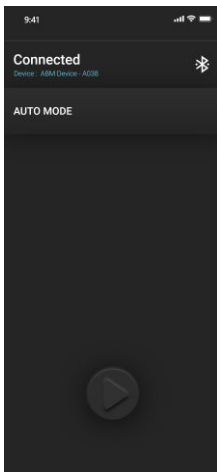

Auto Mode: User can start, pause and resume the therapy from BiWaze Remote Control App.

Manual Mode: User can initiate Inhale (+), Exhale (-) and Pause (No touch) phases from the app. See *section 4.4.1* for details on Manual Mode Therapy.

9.3. Carrying Bag

A carrying bag (BC21083) is available for BiWaze Cough device. When traveling, the carrying bag is for carry-on luggage only. The carrying bag will not protect the system if it is put through checked baggage.

9.4. Device Cart

A device cart (BC22506) is available for BiWaze Cough to be used in an acute care setting. The cart has a mounting plate, a basket, and a stand. The Cart is an optional accessory and can be used to provide mobility in acute and outpatient facilities.

10. Informational Messages

This chapter describes the informational messages that may appear on-screen and troubleshoots some of the problems you may experience with your device and possible solutions to those problems.

The following type of informational messages may appear on-screen.

Message	Description
Therapy complete Information	Provides summary of the current therapy completion.
Error State Information	In case of any technical errors, the Error Message is displayed.

11. Technical Specifications

11.1 Theory of operations

BiWaze Cough is designed around a pneumatic assembly that controls positive as well as negative pressure and flow delivery to the patient. The main processor monitors sensors for pressure, flow and so on, and controls the blowers to meet treatment settings and make breathing comfortable for the user. A number of internal sensor readings are monitored to ensure that the BiWaze Cough functions correctly. Some of them are checked at power up, some at therapy start, and some are monitored continuously.

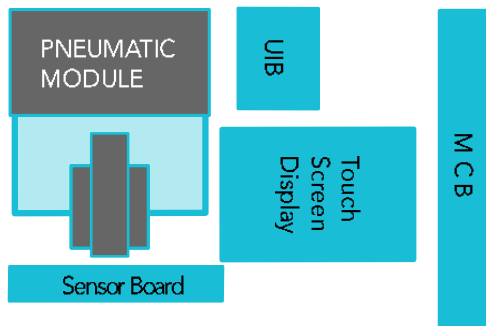

Main Control Board (MCB): This board has multiple processors including main processor for control of pressure and flow. This board controls the positive and negative flow control valves, blowers as well as monitors various temperatures and battery capacity. It also communicates with UI board and Sensor board.

UI Control Board (UIB): This board controls the user interface including the main touch screen LCD as well as USB, HDMI and Foot Pedal ports. This board also provides wireless interfaces for Wi-Fi and Bluetooth connectivity.

Sensor Board: This board provides various pressure and flow sensors required to control as well as monitor the therapy parameters. This board also houses the connectors to peripherals like USB and other ports.

Pneumatic block: This block houses the blowers and valves to deliver air pressure and flow in both positive and negative direction. The pneumatic paths for positive and negative flow are independent.

Basic MI-E / Cough Therapy: Single basic Cough cycle comprises of applying a pause pressure followed by an Inspiratory Pressure and suddenly switching to a negative pressure (Expiratory phase). A cough therapy treatment may have multiple such cycles (usually 5-7 cycles) with pauses in between.

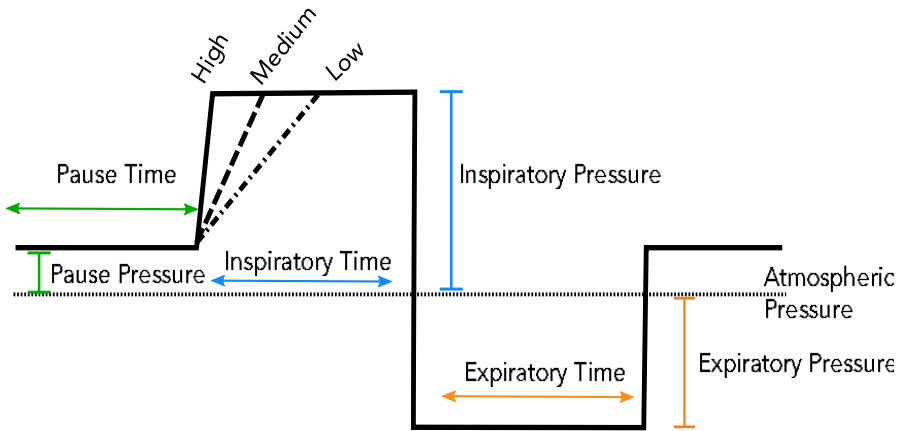

In **Auto Mode** the changes in the pressure are triggered by time settings for pause, inspiratory and expiratory time.

Inspiratory Trigger: If the inspiratory trigger is enabled in advanced settings menu the pause phase is extended till the device detects patient inhale effort and applies the Inspiratory pressures when patient effort is detected. The inspiratory trigger sensitivity can be set in the range 1-10 with 10 being most sensitive.

The trigger works with detection of pressure and flow change created by the patient effort. Both Inspiratory flow and pressure are monitored during the pause phase (every 16ms) when Inspiratory trigger is enabled. The total patient effort detected is compared with predetermined thresholds. A trigger is raised whenever the effort detected exceeds these thresholds.

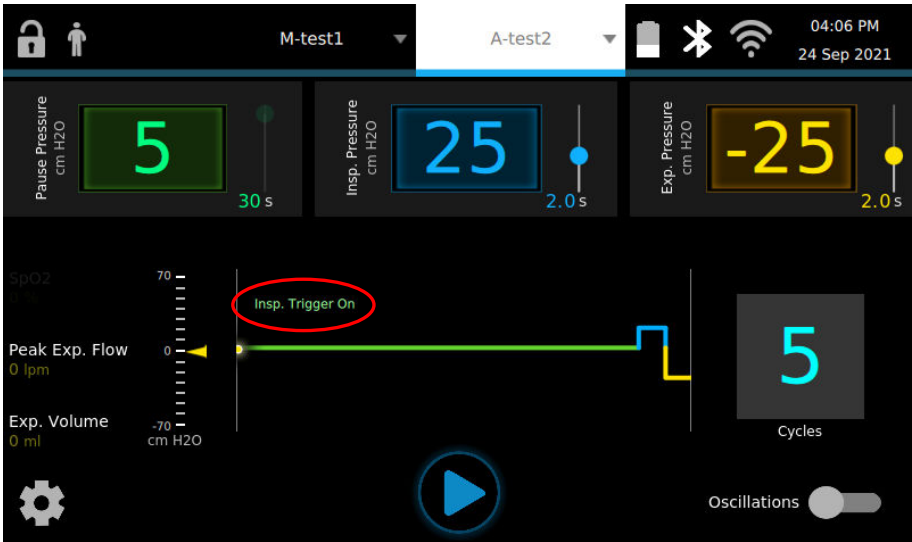

The therapy screen shows the text that trigger is on and allows 30 secs timeout in pause phase to detect patient effort. If patient effort is not detected in that time frame the treatment is paused.

Inspiratory Flow: While the expiratory switching is desired to be fast and at high flow to simulate cough, the inspiratory flow may be controlled to a comfortable level by selecting the flow between low, medium and high.

The High Flow setting applies maximum flow to target the Inspiratory pressure as fast as possible providing maximum peak volumetric flow based on set pause and inspiratory pressure settings.

At Medium setting, the flow is controlled in such a way that the peak volumetric flow observed during Inspiratory phase is within 70% to 40% of that observed when High setting is applied.

At Low setting, the flow during Inspiratory phase is controlled in such a way that the peak volumetric flow observed during Inspiratory phase is within 40% to 10% of that observed when High setting is applied.

Oscillations Control: BiWaze Cough allows 5-20 Hz frequency oscillations on applied pressure to facilitate secretions mobilization. Once enabled the oscillation amplitude can be set at 1-5 levels with 1 as the lowest amplitude.

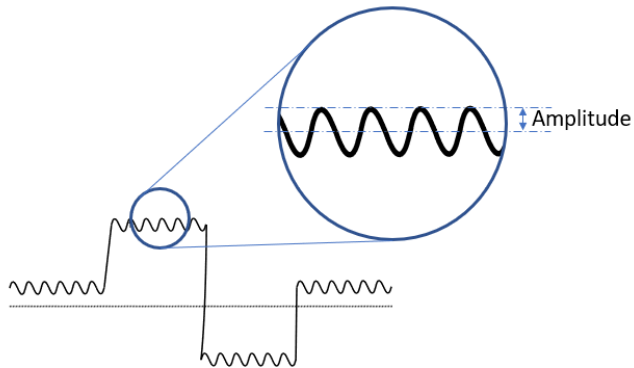

Note: The mean pressure may vary by up to 25% when the oscillations are on depending on the frequency and set pressure.

For Inhale Pressure < 50 cmH₂O, the amplitude setting 1 corresponds to about 20% of the set pressure, 2 corresponds to about 22% of set pressure and so on with an increment of 2% of set pressure for each amplitude with about 30% being the highest.

For Inhale Pressure > 50 cmH₂O, the amplitude setting 1 corresponds to about 30% of the set pressure, 2 corresponds to about 33% of set pressure and so on with an increment of 3% of set pressure for each amplitude with about 42% being the highest.

The amplitude and its tolerance depend on the set pressure, resistance and compliance of the lungs.

11.2 Part Numbers

Catalog Number	Description	Contents
BC21103	BiWaze Cough Airway Clearance System – Standard (2037351818-20113)	BiWaze Cough Assembly ISO Adapter Rechargeable Battery Carry Bag Breathing Circuit with Face Mask - Adult Medium User Manual - English Power Cord
BC20120	Foot Pedal	Foot Pedal with cable assembly
BC21274	Air Inlet Filter (Pack of 3)	Air Inlet Filter (Pack of 3)
BC21095	Battery - Lithium Ion	Lithium Ion Rechargeable Battery
BC21405	Power Cord - UK	Power Cord for UK
BC20116	Power Cord - US	Power Cord for US
BC22496	Patient port adapter	Adapter for connecting standard breathing circuit
BC21084	User Manual English	User Manual (English)

11.3 Product Specification

Therapy Parameter	Specification
Inspiratory Pressure	0 to 70 cmH2O
Inspiratory Time	0 to 5 seconds
Expiratory Pressure	0 to -70 cmH2O
Expiratory Time	0 to 5 seconds
Pause Pressure	0 to 15 cmH2O
Pause Time	0 to 5 seconds
Oscillation Frequency	5 to 20 Hz
Oscillation Amplitude	1 to 5 level
Cycles	1 - 20 number of cycles

11.4 Environmental

	Operating	Storage
Temperature	41 °F to 95 °F (5 °C to 35 °C)	-4 F to 140 F (-20 °C to 60 °C)
Relative Humidity	15 to 95% (non-condensing)	15 to 95% (non-condensing)
Atmospheric Pressure	101 kPa to 77 kPa	105 kPa to 65 kPa

11.5 Physical

Dimensions	27.5 cm L x 23.5 cm W x 9.0 cm H (10.5" L x 9.2" W x 3.5" H)
Weight	3.8 kg (8.4 lbs.) (without battery) 4.1 kg (9.4 lbs.) (with battery installed)

11.6 Standards Compliance

This device is designed to conform to the following standards:

- IEC 60601-1: Medical electrical equipment – Part 1: General requirements for safety
- IEC 60601-1-2: General requirements for safety – Collateral standard: Electromagnetic compatibility – Requirements and tests
- EC 60601-1-11: General requirements for basic safety and essential performance – Collateral standard: Requirements for medical electrical equipment and medical electrical systems used in the home healthcare environment
- IEC 62304: Medical device software — Software life cycle processes
- IEC 62366-1: Medical devices — Part 1: Application of usability engineering to medical devices
- ISO 10993-1 Biological evaluation of medical devices – Part 1: Evaluation and testing (Biocompatibility)
- ISO 14971:: Application of Risk Management for Medical Devices

11.7 Device classifications

AC Voltage Source	100 to 240VAC, 50/60 Hz
AC Power Supply	Input: 100-240 V, 50/60 Hz 1.0-2.0A
Lithium-Ion Battery	Power: 90 Whr Capacity: 3400 mAh
Type of Protection Against Electric Shock	Class II
Degree of Protection Against Electric Shock	Type BF Applied Part
Patient applied part	Face mask and mouthpiece
Degree of Protection against Ingress	Exposure Protection, IP21
Mode of Operation:	Intermittent (30 mins ON – 15 mins OFF)

11.8 Wireless communication

Bluetooth Specification	
Feature	Dimension
Bluetooth Compliance	Bluetooth 4.2 Secure Connection Compliant and CSA2 Support
Frequency	2.4 to 2.48 GHz
Transmit Power	GFSK: 11.7 dBm (Typ)
Receive Sensitivity	GFSK: -92.2 dBm (Typ)
Modulation	Frequency Shift Keying Frequency hopping spectrum

Wi-Fi Specification	
Feature	Dimension
WLAN	IEEE Std 802.11b, 802.11g, and 802.11n with 20 MHz and 40 MHz SISO
Frequency	2412 MHz to 2462 MHz
Transmit Power	1Mbps: 17.4 dBm (Typ) 54 Mbps: 13.8 dBm (Typ) MCS7 (20MHz): 12.6 dBm (Typ) MCS7 (40MHz): 11.3 dBm (Typ)
Receive Sensitivity	1Mbps DSSS: -96.3 dBm (Typ) 54 Mbps OFDM: -74.9 dBm (Typ) MCS7 (20MHz): -72.4 dBm (Typ) MCS7 (40MHz): -67.0 dBm (Typ)
Security Authentication/Encryption	Wi-Fi-protected access (WPA and WPA2.0) and IEEE Std 802.11i (includes hardware-accelerated Advanced Encryption Standard [AES])

11.9 Displayed Parameter Accuracy

Parameter	Accuracy	Resolution	Range
Pressure	> of ± 5 cmH2O or 10% of reading	1 cmH2O	-70 to 70 cmH2O
Peak Expiratory Flow	> of ± 15 lpm or 15%	1 lpm	0-500 lpm
Expired Volume	$\pm (25 + 0.15$ of reading) for peak flows greater than or equal to 20 lpm	1 ml	50-2000 ml

Accuracies stated in this manual are based on specific environmental conditions. For stated accuracy, the environmental conditions are: Temperature: 20-30° C; Humidity: 50% relative; Altitude: nominally 380 meters.

11.10 Control Accuracy

Parameter	Range	Accuracy
Pressure	-70 to 70 cmH ₂ O	± 5 cmH ₂ O
Inhale Time	0-5 seconds	± (10% of setting + 0.1 second)
Exhale Time	0-5 seconds	± (10% of setting + 0.1 second)
Pause Time	0-5 seconds	± (10% of setting + 0.1 second)
Frequency	5-20 Hz	± (10% of setting)
Amplitude	1-5	N/A

Device performance and accuracy is specified at Temperature: 20-30° C; Humidity: 50% relative; Altitude: nominally 380 meters for typical patients.

11.11 Sound

The sound pressure of the device set at -40 cmH₂O/+40 cmH₂O in the Pause phase is less than 60 dBA at 1 meter.

11.12 Disposal

Dispose of this device and accessories in accordance with local regulations. This device and accessories should be disposed of separately, not as unsorted municipal waste. To dispose of your device and accessories, you should use appropriate collection and recycling systems available in your region. The use of these collection and recycling systems is designed to reduce pressure on natural resources and prevent hazardous substances from damaging the environment

11.13 Essential Performance

The Essential Performance of the BiWaze Cough Device is defined as follows:

- Inhale Pressure not to exceed 85 cmH₂O for 1 minute
- Exhale Pressure not to exceed -75 cmH₂O for 5 secs
- Duration of inhale phase in Auto Mode within \pm (10% of the setting + 0.5 seconds)
- Duration of exhale phase in Auto Mode within \pm (10% of the setting + 0.5 seconds)
- All breath phases with times > 0 occurring in proper order in Auto Mode

12. EMC Information



WARNING:

- Portable RF communications equipment (including peripherals such as antenna cables and external antennas) should be used no closer than 30 cm (12 inches) to any part of the BiWaze Cough System, including cables specified by the manufacturer. Otherwise, degradation of the performance of this equipment could result.”
- The BiWaze Cough System should not be used adjacent to or stacked with other equipment. If adjacent or stacked use is necessary, the BiWaze Cough System should be observed to verify normal operation. If operation is not normal, the BiWaze Cough System or the other equipment should be moved.
- Use of accessories, transducers and cables other than those specified or provided by the manufacturer of this equipment could result in increased electromagnetic emissions or decreased electromagnetic immunity of this equipment and result in improper operation.

12.1 Guidance and Manufacturer’s Declaration - Electromagnetic Emissions

This device is intended for use in the electromagnetic environment specified below. The user of this device should make sure it is used in such an environment.

Emissions Test	Compliance	Electromagnetic Environment - Guidance
RF emissions CISPR 11	Group 1	The device uses RF energy only for its internal function. Therefore, its RF emissions are very low and are not likely to cause any interference in nearby electronic equipment.
RF emissions CISPR 11	Class B	The device is suitable for use in all establishments, including domestic establishments and those directly connected to the public low-voltage
Harmonic emissions IEC 61000-3-2	Class A	

Voltage fluctuations/Flicker emissions IEC 61000-3-3	Complies	power supply network that supplies building used for domestic purpose.
---	----------	--

12.2 Guidance and Manufacturer's Declaration - Electromagnetic Immunity

This device is intended for use in the electromagnetic environment specified below. The user of this device should make sure it is used in such an environment.

Immunity Test	IEC 60601 Test Level	Compliance Level	Electromagnetic Environment - Guidance
Electrostatic Discharge (ESD) IEC 61000-4-2	±8 kV contact ±15 kV air	±8 kV contact ±15 kV air	Floors should be wood, concrete or ceramic tile. If floors are covered with synthetic material, the relative humidity should be at least 30%.
Electrical fast Transient/burst IEC 61000-4-4	±2 kV for power supply lines ±1 kV for input-output lines	±2 kV for supply mains Not Applicable	Mains power quality should be that of a typical home or hospital environment.
Surge IEC 61000-4-5	±1 kV line(s) to line(s) ±2 kV line(s) to line(s)	±1 kV line(s) to line(s) Not Applicable	Mains power quality should be that of a typical home or hospital environment.

<p>Voltage dips, short interruptions and voltage variations on power supply input lines</p> <p>IEC 61000-4-11</p>	<p>0% UT for 0.5 cycle at: 0°, 45°, 90°</p> <p>135°, 180°, 225°</p> <p>270° and 315°</p> <p>0% UT for 1 cycle</p> <p>70% UT for 25/30 cycles, single phase at 0°.</p> <p>0% U_T for 250/300 cycles</p>	<p>0% UT for 0.5 cycle at: 0°, 45°, 90°</p> <p>135°, 180°, 225°</p> <p>270° and 315°</p> <p>0% UT for 1 cycle</p> <p>70% UT for 25/30 cycles, single phase at 0°.</p> <p>0% U_T for 250/300 cycles</p>	<p>Mains power quality should be that of a typical home or hospital environment. If the user of the device requires continued operation during power mains interruptions, it is recommended that the device be powered from an uninterruptible power supply or a battery.</p>
<p>Power frequency (50/60 Hz) magnetic field</p> <p>IEC 61000-4-8</p>	<p>30 A/m</p>	<p>30 A/m</p>	<p>Power frequency magnetic fields should be at levels characteristic of a typical home or hospital environment.</p>
<p>NOTE: UT is the AC mains voltage prior to application of the test level.</p>			

12.3 Guidance and Manufacturer’s Declaration - Electromagnetic Immunity

This device is intended for use in the electromagnetic environment specified below. The user of this device should make sure it is used in such an environment.

Immunity Test	IEC 60601 Test Level	Compliance Level	Electromagnetic Environment - Guidance
<p>Conducted RF IEC 61000-4-6</p> <p>Radiated RF IEC 61000-4-3</p>	<p>3 Vrms 150 kHz to 80 MHz</p> <p>6Vrms in ISM bands between 150KHZ to 80MHz</p> <p>10 V/m 80 MHz to 2.7 GHz</p>	<p>3 Vrms</p>	<p>The BiWaze Cough is suitable for the electromagnetic environment of typical homes or hospital settings.</p> <p>Portable and mobile RF communications equipment should be used no closer to any part of the device, including cables, than the recommended separation distance calculated from the equation applicable to the frequency of the transmitter.</p> <p>Recommended separation distance: $d = 1.2\sqrt{P}$</p> <p>$d = 1.2\sqrt{P}$ 80 MHz to 800 MHz $d = 2.3\sqrt{P}$ 800 MHz to 2.7 GHz</p> <p>where P is the maximum output power rating of the transmitter in watts (W) according to the transmitter manufacturer and d is the recommended separation distance in meters (m).</p>

			<p>Field strengths from fixed RF transmitters, as determined by an electromagnetic site survey, should be less than the compliance level in each frequency range.</p> <p>Interference may occur in the vicinity of equipment marked with the following symbol.</p> <p></p>
--	--	--	---

NOTE 1 At 80 MHz and 800 MHz, the higher frequency range applies.

NOTE 2 These guidelines may not apply in all situations. Electromagnetic propagation is affected by absorption and reflection from structures, objects, and people.

Field strengths from fixed transmitters, such as base stations for radio (cellular/cordless) telephones and land mobile radios, amateur radio, AM and FM radio broadcast and TV broadcast cannot be predicted theoretically with accuracy. To assess the electromagnetic environment due to fixed RF transmitters, an electromagnetic site survey should be considered. If the measured field strength in the location in which the device is used exceeds the applicable RF compliance level above, the device should be observed to verify normal operation. If abnormal performance is observed, additional measures may be necessary, such as re-orienting or relocating the device.

Over the frequency range 150 kHz to 80 MHz, the field strengths should be less than 3 V/m.

12.4 Recommended Separation Distances between Portable and Mobile RF Communications Equipment and This Device

The device is intended for use in an electromagnetic environment in which radiated RF disturbances are controlled. The customer or the user of this device can help prevent electromagnetic interference by maintaining a minimum distance between portable and mobile RF communications equipment (transmitters) and this device as recommended below, according to the maximum output power of the communications equipment.

Rated Maximum Power Output of Transmitter (Watts)	Separation Distance According to Frequency of Transmitter (meters)		
	150 kHz to 80 MHz outside ISM Bands $d = 1.2\sqrt{P}$	80 MHz to 800 MHz $d = 1.2\sqrt{P}$	800 MHz to 2.5GHz $d = 2.3\sqrt{P}$
0.01	0.12	0.12	0.23
0.1	0.38	0.38	0.73
1	1.2	1.2	2.3
10	3.8	3.8	7.3
100	12	12	23

For transmitters rated at a maximum output power not listed above, the recommended separation distance d in meters (m) can be estimated using the equation applicable to the frequency of the transmitter, where P is the maximum output power of the transmitter manufacturer.

Note 1: At 80 MHz and 800 MHz, the separation distance for the higher frequency range applies.

Note 2: These guidelines may not apply in all situations. Electromagnetic propagation is affected by absorption and reflection from structures, objects and people.

12.5 Guidance and Manufacturer's Declaration - Electromagnetic Immunity to Wireless Communications Equipment

The device is intended for use in the electromagnetic environment specified below. The customer or user of the device should make sure is used in such an environment.

Sides Tested	Frequency (MHz)	Test Severity Level
Left, Right	385	27V/m, 50%PM 18Hz
Left, Right	450	28V/m, FM+5kHz, 1kHz
Left, Right	710, 745, 780	9V/m, 50%PM, 217Hz
Left, Right	810, 870, 930	28V/m, 50%PM, 18Hz
Left, Right	1720, 1845, 1970, 2450	28V/m, 50%PM, 217Hz
Left, Right	5240, 5500, 5785	9V/m, 50%PM, 217Hz

12.6 Federal Communications Commission (FCC) Radiation Exposure Statement

This device complies with Part 15 of the FCC rules. Operation is subject to the following two conditions: (1) this device may not cause harmful interference, and (2) this device must accept any interference received, including interference that may cause undesired operation.

To maintain compliance, the device must be used with specified BiWaze Cough accessories supplied or designated for this product. Use of other accessories may not ensure compliance with FCC RF exposure guidelines.

NOTE:

The module must be used in strict accordance with the manufacturer's instructions as described in the user documentation that comes with the product. Modifications not expressly approved by manufacturer could void your authority to operate the equipment.

The device is also registered under Infocomm Media Development Authority (IMDA), Singapore. The compliance label shows the license details.

Complies with BMDA Standards [DB107612]

13. Trouble Shooting

In case the BiWaze Cough device user runs into any device related issues, some of the issues are self-explanatory and relevant messages are displayed on screen to allow user to take necessary action to come out of the error condition. For other issues related to device problems user may require servicing the device from ABM Respiratory Care authorized service centre. Please get in touch with your health care provider for such service needs. Refer to *Section 2.4* for contact details.

Example: Error Message and details when information icon is pressed on the Error Message

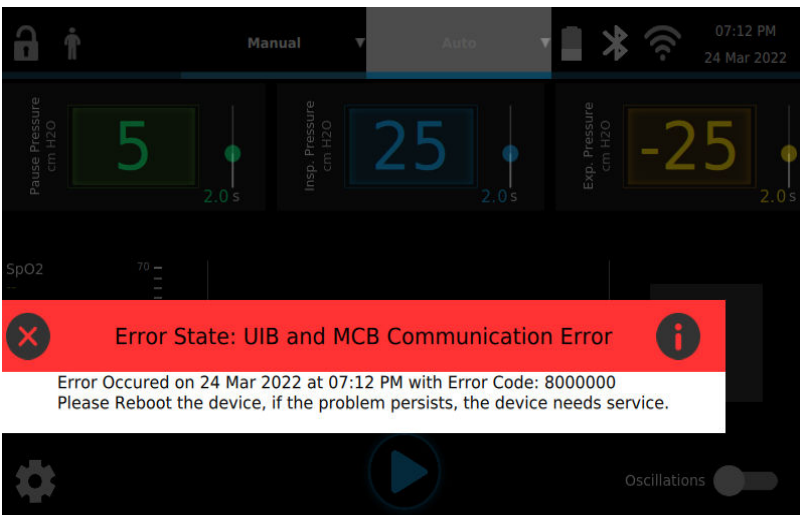
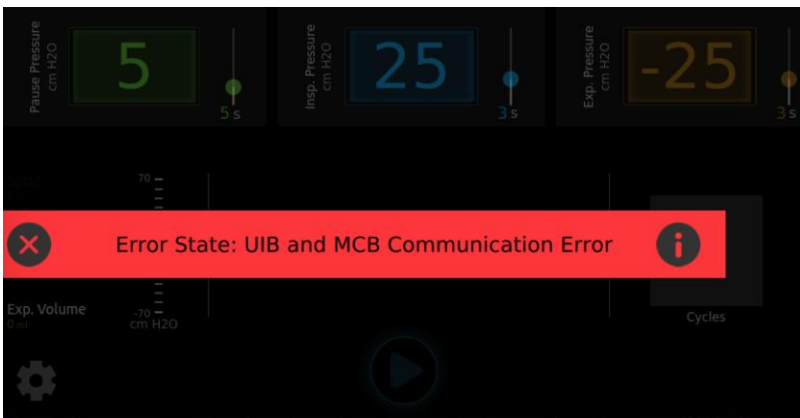

Event Type	Description	Action
<p>Device shows a Red Strip with Error: High Temperature</p>	<p>The device temperature is high.</p>	<p>Check if the device is ventilated properly and not covered with cloth or other items. Ensure its placed on hard surface with space on all sides. Switch off the device and restart after 15 minutes of cool down.</p>
		<p>Move the device away from any sources of heat or hot ambient temperatures. Switch off the device and restart after 15 minutes of cool down.</p>
		<p>If problem persists, call your health care provider for servicing the device to replace the filters and functional check.</p>
<p>Device does not power up</p>	<p>Battery may be too low.</p>	<p>Connect the device to mains power and check if the device powers up.</p> <p>If problem persists, call your health care provider for service.</p>
<p>Technical errors with an error code number on a Red strip on the LCD Screen and device shuts down after few seconds</p>	<p>Technical error related to temperatures or other high priority fault</p>	<p>Try rebooting the device and if problem persists, call your health care provider for service.</p>

Event Type	Description	Action
<p>Technical errors with an error code number on a Red strip on the LCD Screen and device does not shut down. User cannot start the therapy.</p>	<p>Technical error related to subsystem malfunction</p>	<p>Try rebooting the device and if problem persists, call your health care provider for service.</p>
<p>Information with a self-explanatory message on the LCD screen in an Orange strip.</p>	<p>Informational messages</p>	<p>User can acknowledge and continue with therapy. Take action based on informational message if needed.</p>
<p>Device not performing as intended. Making abnormal sounds or therapy performance.</p>	<p>Device performance malfunction.</p>	<p>Ensure that you move away from any high electromagnetic or RF radiation sources like MR machines, power transformers etc.</p> <p>If problem persists, do not use the device and call your healthcare provider for the service.</p>

The following types of error messages along with their error codes may appear on-screen in case of device malfunction.

Sl. No.	Error Message	Error Codes
1	Inspiratory Blower Error	1
2	Expiratory Blower Error	2
3	Insp. Pressure Sensor Error	4
4	Exp. Pressure Sensor Error	8
5	Insp. Flow Sensor Error	10
6	Exp. Flow Sensor Error	20
7	Barometric Pressure Sensor Error	40
8	Excess Pressure	80
9	High Delivered Air Temperature	100
10	High Battery Temperature	200
11	Positive Stepper Motor Error	400
12	Negative Stepper Motor Error	800
13	High MCB Temperature	1000
14	MCB Temperature Sensor Fail	2000
15	Delivered Air Temperature Sensor Fail	4000
16	Battery Temperature Sensor Fail	8000
17	Stepper Communication Error	10000
18	Pressure Sensor Mismatch	20000
19	Blower Calibration Error	40000
20	Flow Sensor Calibration Error	80000
21	High Leak Detected	100000
22	Mask Off Detected	200000
23	Low Battery Temperature	400000
24	Low MCB Temperature	800000
25	Low Patient Air Temperature	1000000
26	PMB and MCB Communication Error	2000000
27	Battery Charging Error	4000000
28	UIB and MCB Communication Error	8000000
29	Low Battery	10000000
30	Critical Low Battery	20000000
31	High Ambient Temperature Error	40000000
32	Stepper Value Slip Error	80000000

Note: In case of above Error code or any other issue/ Error code, contact ABM Respiratory Care (refer section 2.4 for contact details).

14. Limited Warranty

ABMRC LLC warrants that the BiWaze Cough shall be free from defects of workmanship and materials and will perform in accordance with the product specifications for a period of one (1) year from the date of sale by ABMRC, LLC to the dealer. If the product fails to perform in accordance with the product specifications, ABMRC, LLC, will repair or replace – at its option – the defective material or part. ABMRC, LLC will pay customary freight charges from ABMRC, LLC to the dealer location only. This warranty does not cover damage caused by accident, misuse, abuse, alteration, and other defects not related to material or workmanship.

ABMRC, LLC disclaims all liability for economic loss, loss of profits, overhead, or consequential damages which may be claimed to arise from any sale or use of this product. Some states do not allow the exclusion or limitation of incidental or consequential damages, so the above limitation or exclusion may not apply to you.

The warranty for accessories or consumables is as below;

Accessory/Consumable	Warranty Period
Battery	90 days
Carrying Bag	30 days
Foot Pedal	90 days

Other accessories and replacement parts, including, but not limited to, circuits, tubing, leak devices, exhaust valves, filters and fuses, are not covered under this warranty.

This warranty is given in lieu of all other express warranties. In addition, any implied warranties – including any warranty of merchantability or fitness for the particular purpose – are limited to one year. Some states do not allow limitations on how long an implied warranty lasts, so the above limitation may not apply to you. This warranty gives you specific legal rights, and you may also have other rights which vary from state to state.

To exercise your rights under this warranty, contact your local authorized dealer or contact ABM Respiratory Care. For contact details, refer to Section 2.4.

15. Service Instructions

To have your device serviced, contact your provider. Refer to *Section 2.4* to contact ABM Respiratory Care Customer Service.

CAUTION:

Do not remove the top cover or disassemble the device as there are no serviceable parts inside. The device should be serviced by authorized personnel only.

Do not modify this equipment. No modification of this equipment is allowed by any unauthorized personnel.

15.1 Expected Service Life

The service life for various subsystems is as follows:

Main Device	5 Years
Power Cord	5 Years
Breathing circuit kit	30 days after unpacking or 90 therapy cycles
Carry Bag	2 years
Battery	1 year
Device Cart	3 Years

15.2 FRU and Spare parts

There are no field replaceable spare parts orderable for service.

15.3 Planned Maintenance

There is no requirement for planned maintenance of this device.

15.4 Service Cleaning and Maintenance

There is no field service applicable for the device. Any returns to the manufacturer shall be cleaned before shipping.



ABMRC LLC
860 Blue Gentian Road
Suite 200
Eagan, MN 55121
USA

REF

2037351818-20113

URM

2037351818-21084

BC21084

9.0

Issue date: April 2022

UI Software Version

1.X.0